



Accessories for vineyard & orchard



Index

TIE FOR VINE-SHOOT	→ PAGE 1-5
ACCESSORIES	→ PAGE 6-12
SUPPORTS	→ PAGE 13-14
SPRINGS SPACER	→ PAGE 15-16
COLLARS AND BANDS	→ PAGE 17-22
ANCHORS	→ PAGE 23-25
U-BOLTS	→ PAGE 26
ANTI-SINKING PLATES	→ PAGE 27
STAINLESS STEEL WIRE	→ PAGE 28

TIE FOR VINE-SHOOT

TIE FOR VINE-SHOOT

SIZE	Ø	MATERIAL	CODE
L75	1.60	STAINLESS STEEL	000 01 014
L100	1.60		115 99 005

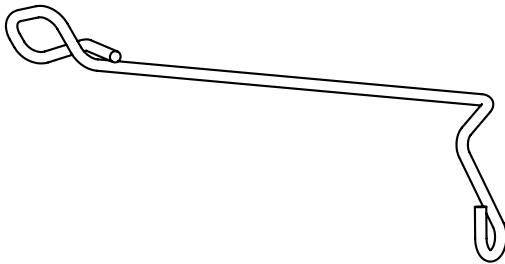
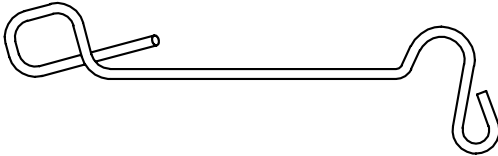

SIZE	Ø	MATERIAL	CODE
L96	1.80	STAINLESS STEEL	000 03 005

TIE FOR MECHANICAL GRAPE HARVEST

SIZE	Ø	MATERIAL	CODE
L95	1.60	STAINLESS STEEL	171 06 002

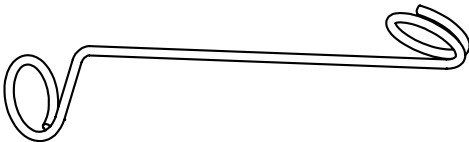

BENDED TIE WITH DOUBLE TWIST

SIZE	Ø	MATERIAL	CODE
L80	1.60	STAINLESS STEEL	000 04 013
L100	1.60		000 04 314
L100	1.80		000 04 114

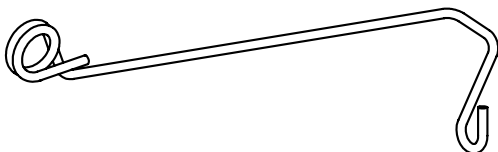

WIRE FOR MECHANICAL GRAPE HARVEST

SIZE	Ø	MATERIAL	CODE
L110	2.00	STAINLESS STEEL	171 06 005
L110	2.00	GALVANIZED STEEL	171 06 105

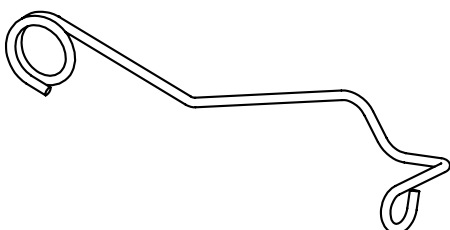

TIE FOR VINE-SHOOT

FIXING WIRE FOR BAMBOO/METAL STAKE

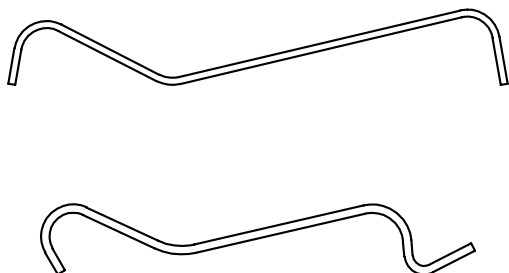

SIZE	Ø	MATERIAL	CODE
L112	2.50	GALVANIZED STEEL	000 99 006
L145	3.00	GALVANIZED STEEL	000 03 114
L145	3.00	STAINLESS STEEL	000 03 214
L178	3.00	GALVANIZED STEEL	000 03 012
L178	3.00	STAINLESS STEEL	000 03 212
L215	3.00	GALVANIZED STEEL	000 03 013

SIZE	Ø	MATERIAL	CODE
L155	3.00	GALVANIZED STEEL	245 08 106

FIXING WIRE FOR BAMBOO/METAL STAKE

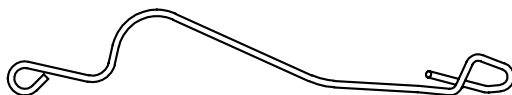

SIZE	Ø	MATERIAL	CODE
L160	2.00	GALVANIZED STEEL	000 02 020
L160	2.00	STAINLESS STEEL	000 02 120
L160	2.50	GALVANIZED STEEL	000 02 022
L160	2.50	STAINLESS STEEL	000 02 122

FIXING WIRE FOR BAMBOO/METAL STAKE

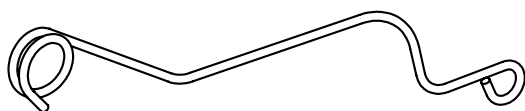

SIZE	Ø	MATERIAL	CODE
L150	2.00	GALVANIZED STEEL	171 02 002
L150	2.00	STAINLESS STEEL	171 02 102
L150	2.50	GALVANIZED STEEL	171 04 001
L150	2.50	STAINLESS STEEL	171 04 101
L245	2.50	GALVANIZED STEEL	169 08 001
L245	2.50	STAINLESS STEEL	169 08 101

FIXING WIRE "L" TYPE FOR METAL STAKE/BAMBOO

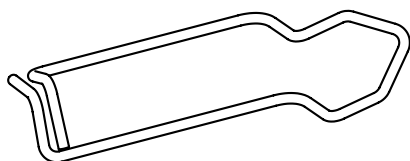

STAKE SIZE	Ø	MATERIAL	CODE
6-10	1.60	STAINLESS STEEL	000 05 027
6-10	1.60	GALVANIZED STEEL	000 05 127
6-10	1.60	LEGAINOX	000 05 227
10-16	1.60	STAINLESS STEEL	000 05 028
10-16	1.60	GALVANIZED STEEL	000 05 128
10-16	1.60	LEGAINOX	000 05 228
6-10	1.70	STAINLESS STEEL	000 18 024

TIE FOR VINE-SHOOT

STABFIX

SIZE	Ø	MATERIAL	CODE
L80	2.00	GALVANIZED STEEL	169 06 001

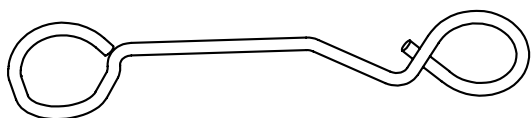

SPEEDY FIXING STAKE

WIRE SIZE	Ø	MATERIAL	CODE
6-10	1.60	STAINLESS	000 05 017
10-16	1.60		000 10 001
16-20	1.60	STEEL	000 10 002
20-26	1.60		000 10 003

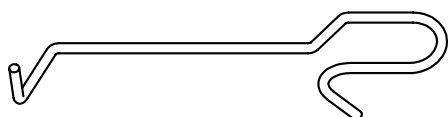

GALVANIZED STEEL
ON REQUEST

TOP FIXING STAKE

SIZE	Ø	MATERIAL	CODE
6-10	2.00	GALVANIZED STEEL	000 17 019

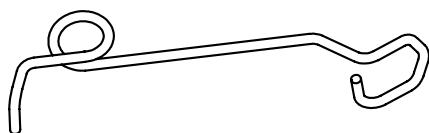

STANFIX

SIZE	Ø	MATERIAL	CODE
L90	2.00	GALVANIZED STEEL	194 06 004

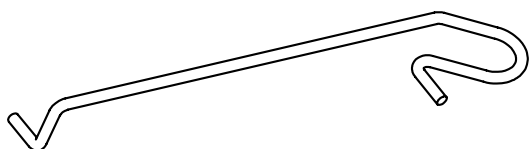

FIXING STAKE

SIZE	Ø	MATERIAL	CODE
L65	2.00	STAINLESS STEEL	171 02 001
L80	2.00		171 02 003

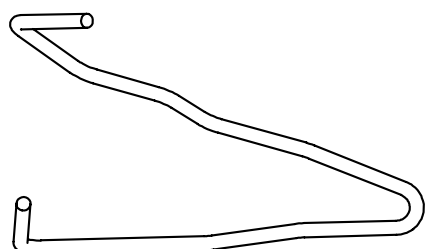

TIE FOR VINE-SHOOT

PFAHLFIX

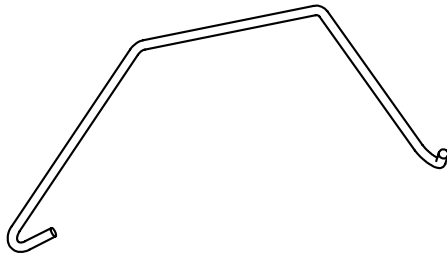

POLE	Ø	MATERIAL	CODE
5x5	3.00	GALVANIZED STEEL	169 09 005
6x6			169 09 006
7x7			169 05 003
7x8			169 09 008
8x8			169 09 003
8x8.5			000 10 022
9x9			000 09 015
9x9.5			000 17 006
10x12			000 17 007

BOUNDFIX

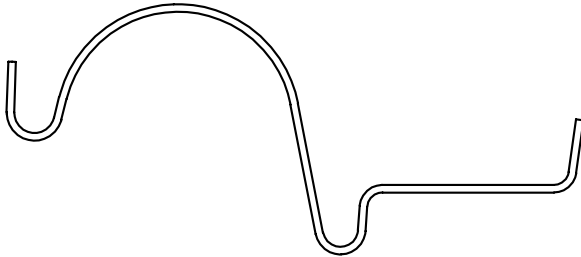

POLE	Ø	MATERIAL	CODE
6x6	3.00	GALVANIZED STEEL	175 07 001
6.5x6.5			175 07 002
7x7			175 06 003
7x8			175 06 001
8x8			116 06 003
8.5x8.5			231 09 002
9x9			231 09 001
9.5x9			169 07 001

PLANTFIX

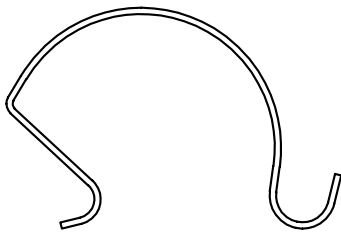

TYPE	Ø	MATERIAL	CODE
50	2.00	GALVANIZED STEEL	169 02 009
70	2.50		169 02 007
120	2.50		169 04 001

KIWI FIXING STAKE

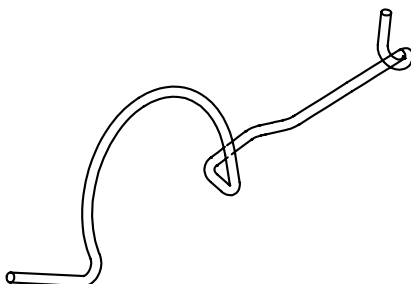

Ø	MATERIAL	CODE
2.00	STAINLESS STEEL	000 06 015

TIE FOR VINE-SHOOT

SAULENFIX



TYPE	Ø		MATERIAL	CODE
7x7	3.00	247	GALVANIZED	000 13 006
8x8	3.00	280		000 13 007
9x9	3.00	300		000 13 008

"WIRE STOP" HOOK



Ø	MATERIAL	CODE
3.00	GALVANIZED STEEL	169 04 002

BAMBUGEL

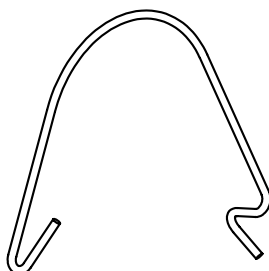
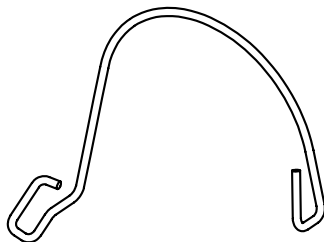
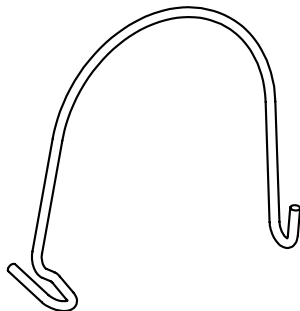

Ø	MATERIAL	CODE
3.00	GALVANIZED STEEL	169 03 007

TYPE	Ø	Ø	MATERIAL	CODE
NORM.	2.50	UP TO Ø70	GALVANIZES STEEL	169 05 002
XL	2.50	OVER Ø70		169 10 001

Ø	MATERIAL	CODE
2.50	GALVANIZED STEEL	175 06 002

ACCESSORIES

DOUBLE NAILS

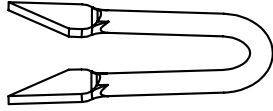

SIZE	Ø	MATERIAL	CODE
SHORT 35mm	3.00	STAINLESS STEEL	171 07 017
LONG 50mm	3.00		171 07 021

DOUBLE NAILS

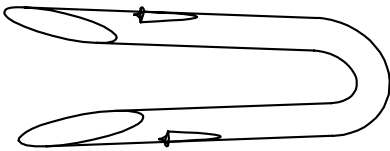

Ø	MATERIAL	CODE
4.00	CRAPAL	000 06 004

SPACER NAIL

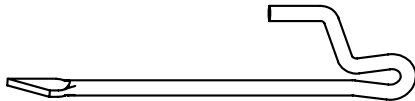

Ø	MATERIAL	CODE
3.00	STAINLESS STEEL	171 07 010

NAIL

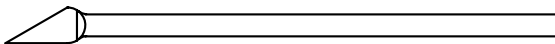

SIZE	Ø	MATERIAL	CODE
L100	4.00	STAINLESS STEEL	171 07 022

WIRE HOOK



Ø	MATERIAL	CODE
2.5	STAINLESS STEEL	381 08 006

Ø	MATERIAL	CODE
2.5	STAINLESS STEEL	461 16 001

ACCESSORIES

WIRE TENSIONER "GRILLO"

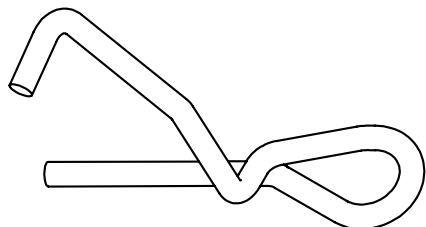

Ø	MATERIAL	CODE
5.20	CRAPAL	115 02 101

TENSIONER

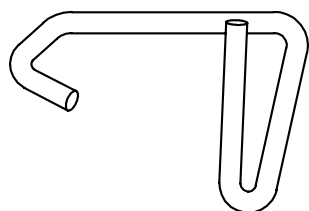

Ø	MATERIAL	CODE
5.00	STAINLESS STEEL	171 07 013

TRACTION SPRING

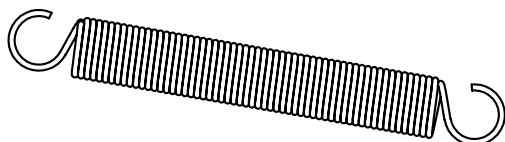

SIZE	Ø	MATERIAL	CODE
L180	2.50	GALVANIZED STEEL	000 09 017

FLAT "S" HOOK

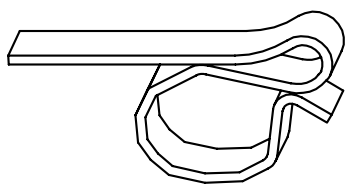

STRIP	MATERIAL	CODE
7x1	STAINLESS STEEL	000 05 010

COTTER PIN

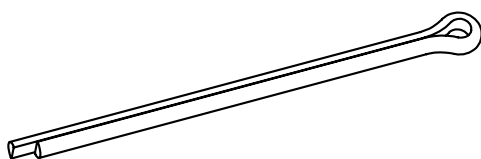

SIZE	MATERIAL	CODE
L100	HOT DIP GALV.	259 09 002
L100	STAINLESS STEEL	259 09 102

ACCESSORIES

TAKE-UP ROLLERS

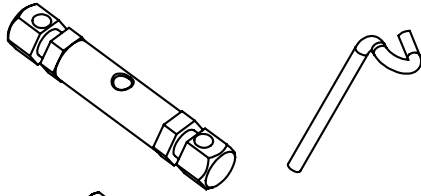

COMPONENTS	MATERIAL	CODE
EXAGONAL TRF 13	STAINLESS	000 15 005
SECURITY HOOK Ø4	STEEL	171 06 011

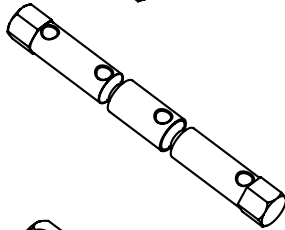

COMPONENTS	MATERIAL	CODE
EXAGONAL TRF 13	STAINLESS	000 13 002
SECURITY HOOK Ø4	STEEL	171 06 011

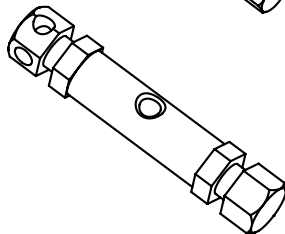

COMPONENTS	MATERIAL	CODE
EXAGONAL TRF 13	STAINLESS	000 17 110
SECURITY HOOK Ø4	STEEL	171 06 011

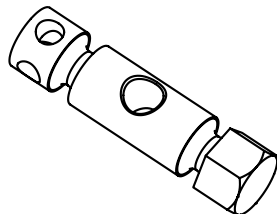

COMPONENTS	MATERIAL	CODE
EXAGONAL TRF 13	STEEL +	000 08 008
SECURITY HOOK Ø4	HOT DIP. GALV.	171 06 011

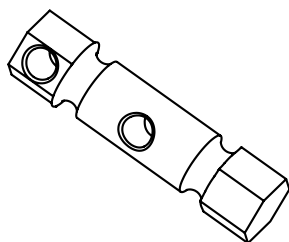

COMPONENTS	MATERIAL	CODE
EXAGONAL TRF 11	STAINLESS	000 08 015
SECURITY HOOK Ø4	STEEL	171 06 011

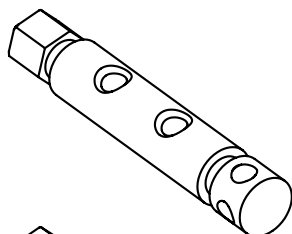

COMPONENTS	MATERIAL	CODE
EXAGONAL TRF 15 L85	STEEL +	000 17 011
SECURITY HOOK Ø4	HOT DIP. GALV.	171 06 011

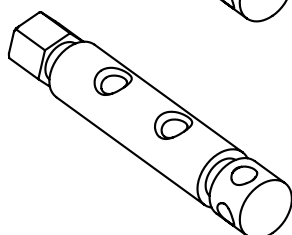

COMPONENTS	MATERIAL	CODE
EXAGONAL TRF 15 L102	STEEL +	000 19 008
SECURITY HOOK Ø4	HOT DIP. GALV.	171 06 011

ACCESSORIES

TAKE-UP ROLLER WITH SECURITY HOOK

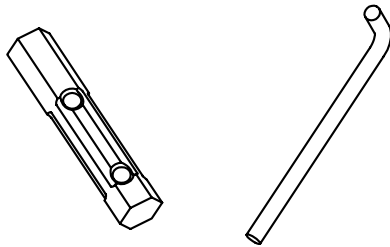

COMPONENTS	MATERIAL	CODE
EXAGONAL TRF 13	STAINLESS	245 08 004
SECURITY HOOK Ø5	STEEL	171 07 012

WIRE HOOK FOR CONCRETE POST

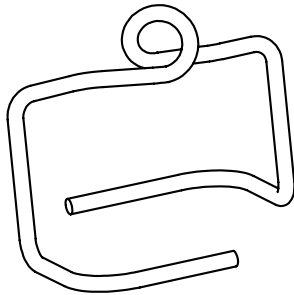

Ø	MATERIAL	CODE
3.50	STAINLESS STEEL	000 09 020

UPPER-POST SPRING

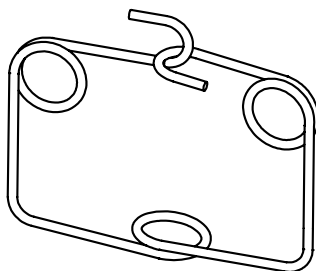

Ø	MATERIAL	CODE
2.50	STAINLESS STEEL	203 16 001

ACCESSORIES

DOUBLE HOOK FOR TEXTILE

SIZE	Ø	MATERIAL	CODE
L55	3.00	GALVANIZED STEEL	043 97 003

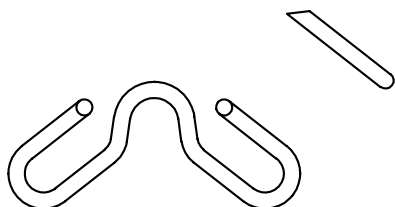

NEEDLE STOP

SIZE	Ø	MATERIAL	CODE
L180	2.50	GALVANIZED STEEL	000 04 009
L180	2.50	STAINLESS STEEL	000 04 109

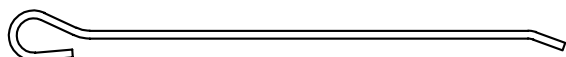

RING FOR ANTI-HAIL TEXTILE

Ø	ØINT	MATERIAL	CODE
8.00	70	GALVANIZED STEEL	000 09 005
8.00	70	STEEL + HOT DIP. GALV.	000 09 105
8.00	90	GALVANIZED STEEL	000 10 035
8.00	90	STEEL + HOT DIP. GALV.	000 10 135

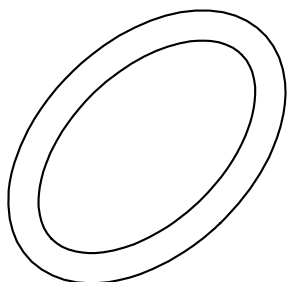

ACCESSORIES

FIXING HOOK FOR IRRIGATION

SIZE	Ø	MATERIAL	CODE
L 152	2.00	STAINLESS STEEL	381 08 004

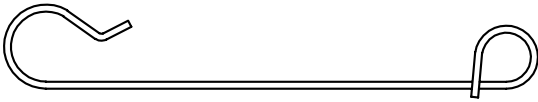

FIXING HOOK FOR PARALLEL WIRES

SIZE	Ø	MATERIAL	CODE
L 56	2.50	STAINLESS STEEL	000 09 016

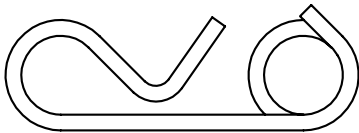

ROPE CLAMP M8
ROPE CLAMP M10

TYPE	D.	LENGTH	MATERIAL	CODE
M8	4.5	120	GALV.STEEL	169 10 007
M8	3.5	145	GALV.STEEL	169 05 101
M8	3.5	145	STEEL + HOT DIPPED GALVA.	169 05 201
M8	4.5	180	GALV.STEEL	169 10 008
M10	4.5	120	GALV.STEEL	169 10 107
M10	3.5	145	GALV.STEEL	169 05 301

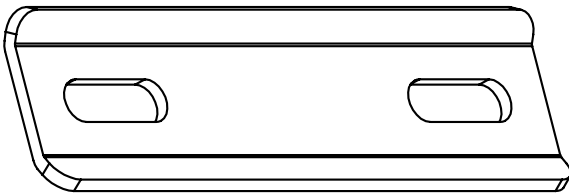

ROPE CLAMP M8
ROPE CLAMP M10

Only on request
all brackets could be supplied with U-Bolts and nuts

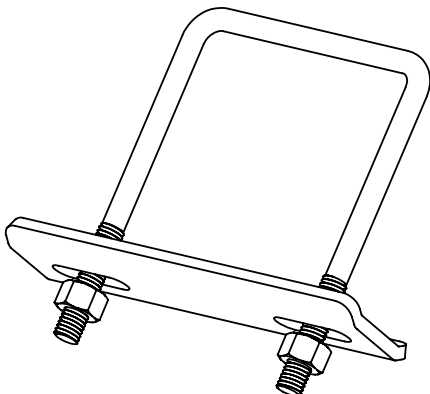

ACCESSORIES

CRAPAL CHAIN 7LINKS (22 CM LENGTH)

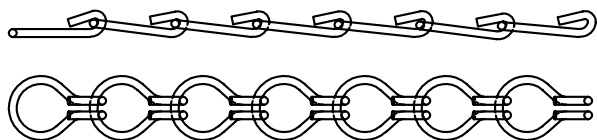

Ø	MATERIAL	CODE
3.10	CRAPAL	000 03 016

STAINLESS STEEL CHAIN 24x8

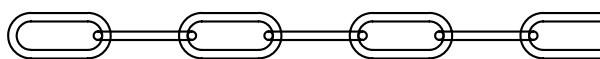

Ø	MATERIAL	CODE
2.40	STAINLESS STEEL	000 07 200

CHAIN SUPPORT FOR PROFIL ALSACE METAL POST



Ø	MATERIAL	CODE
3.00	STAINLESS STEEL	000 99 010
4.00		000 99 110

CHAIN SUPPORT FOR PROFIL ALSACE METAL POST

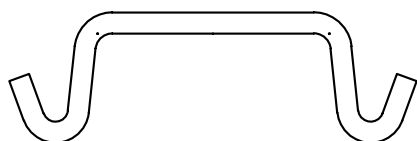

Ø	MATERIAL	CODE
4.00	STAINLESS STEEL	169 02 105
5.00		169 02 005

CHAIN COLLAR

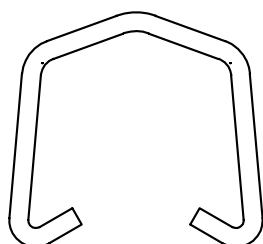

Ø	MATERIAL	CODE
5.00	STAINLESS STEEL	000 09 013

SUPPORTS

SUPPORT FOR WIRE (DIMENSION ON REQUEST)

Ø	MATERIAL	CODE
2.80	STAINLESS STEEL	

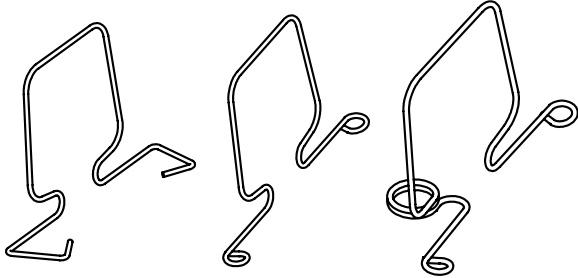

FIXED SUPPORT FOR WIRES

POLE	Ø	MATERIAL	CODE
7x7	2.80	STAINLESS STEEL	000 99 003
8x8	2.80		000 99 004
9x9	2.80		000 99 005



SUPPORTS

SPRING FOR CONCRETE ROUND POST

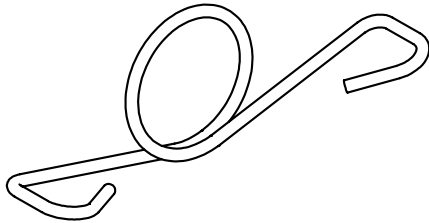

ØPOLE	Ø	MATERIAL	CODE
5x5	60	GALVANIZED STEEL Ø3.50	169 02 002
6x6	70		169 02 003
7x7	80		169 02 004

CROSS ARM/SPACER "FUSAXE"

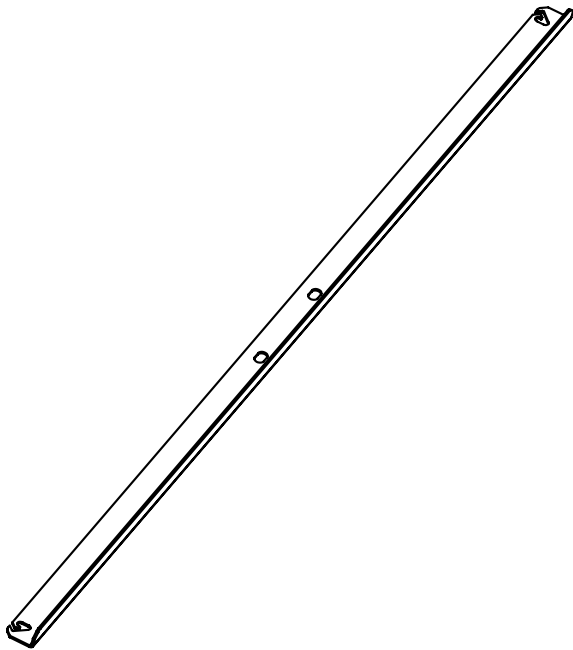

LENGTH	D.	MATERIAL	CODE
250	1.50	GALVANIZED STEEL	169 10 002
400	1.50		169 03 008
600	1.50		169 03 001
600	2.00		169 03 301
600	3.00		169 03 201
800	1.50		169 03 002
800	2.00		169 03 102
800	3.00		169 03 202
1000	2.00		169 03 009

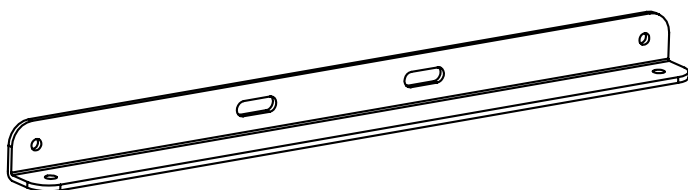

LENGTH	D.	MATERIAL	CODE
350	3.00	GALVANIZED STEEL	000 10 029
400	3.00		000 12 003
450	3.00		000 10 014
550	3.00		000 10 030

SPRINGS SPACER

SPRING SPACER FOR METAL POST (VARIOUS DIMENSIONS AND TYPES)

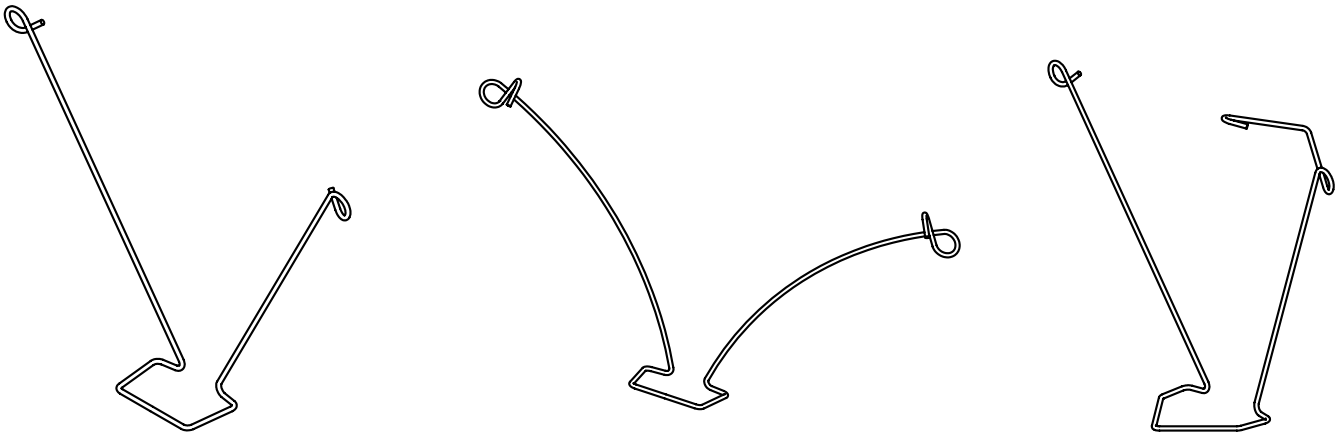

SPRING SPACER MODEL "LAMPO" FOR CONCRETE AND METAL POST (VARIOUS DIMENSIONS AND TYPES)

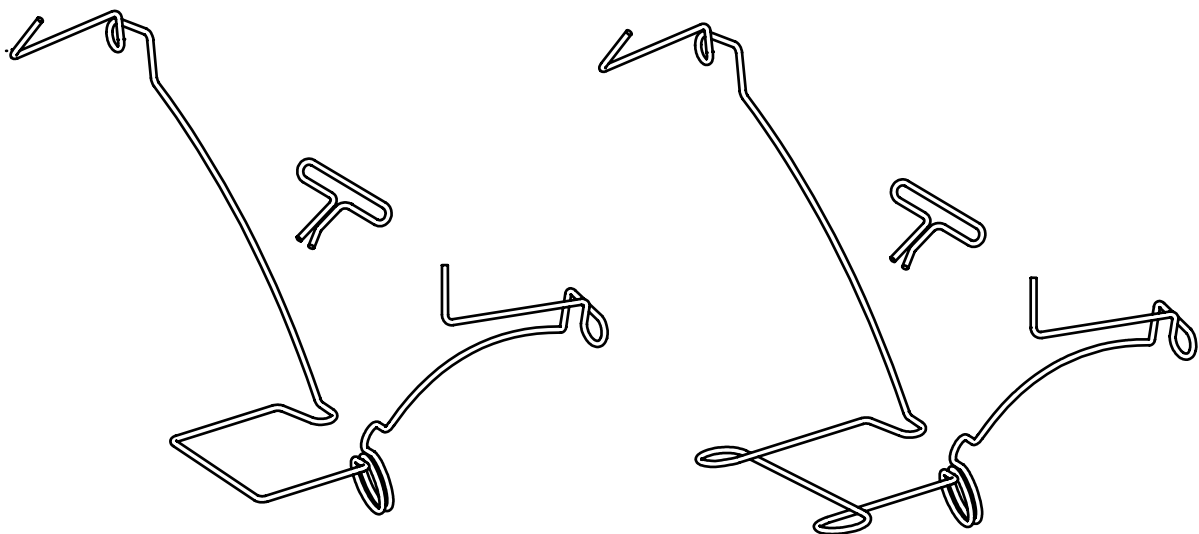

SPRINGS SPACER

SPRING SPACER FOR WOOD POST

Ø	MATERIAL	CODE
2.50	STAINLESS STEEL	000 99 027
2.50		000 99 052

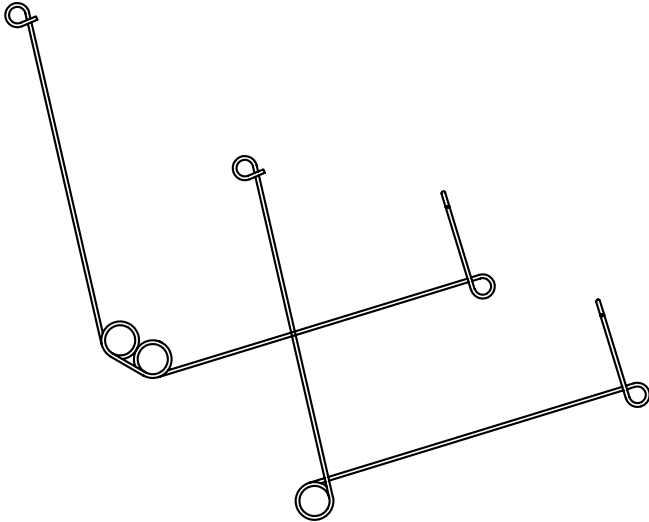

SPRING SPACER FOR ROUND WOOD POST
(VARIOUS DIMENSIONS AND TYPE)

Ø	MATERIAL	CODE
2.50	STAINLESS STEEL	

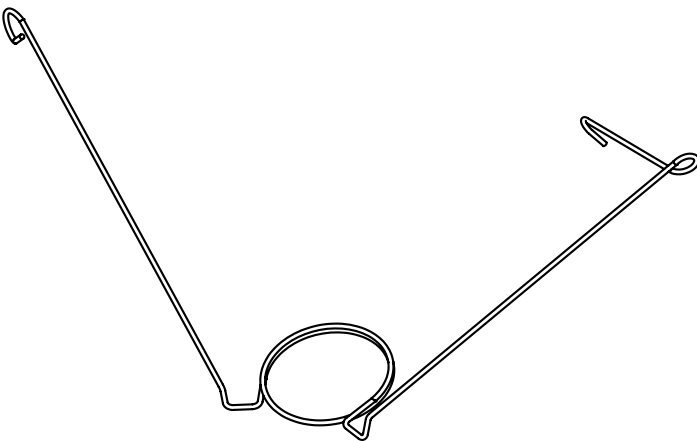

COLLARS AND BANDS

COLLAR FOR ROUND POLE

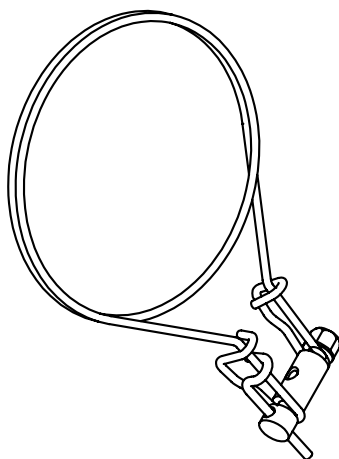

ØPOLE	MATERIAL	CODE
10	STAINLESS STEEL	171 08 502
12		171 06 507
14		171 06 514
16		171 06 515

BANDS FOR ROUND POLE

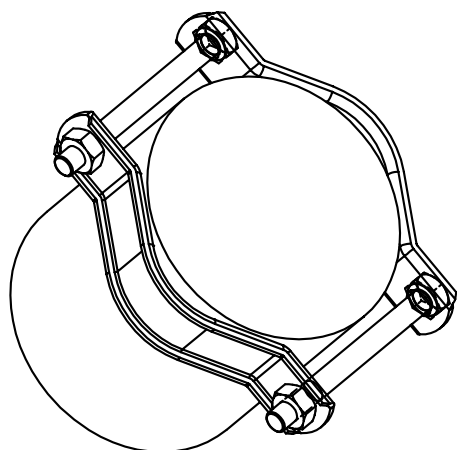

MATERIAL		CODE
STEEL + HOT DIP. GALV.	couple complete with fasteners & nuts	000 06 119
STEEL + HOT DIP. GALV.	single band without fasteners & nuts	000 06 019

WIRE COLLAR FOR SQUARE POST

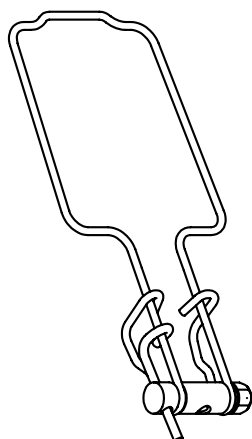

POLE	Ø	MATERIAL	CODE
5x5	4.00	STAINLESS STEEL	171 11 503
8x9	4.00		171 07 516

COLLARS AND BANDS

HOOK FOR TIE ROD

Ø	MATERIAL	CODE
4.00	STAINLESS STEEL	171 07 514

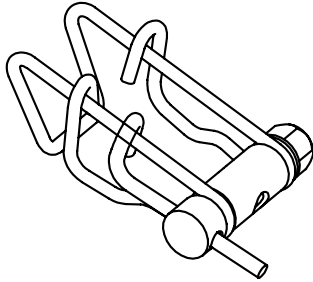

COLLAR FOR CHAIN

ØPOLE	MATERIAL	CODE
10	STAINLESS STEEL Ø2.8	201 10 001
12		201 10 002

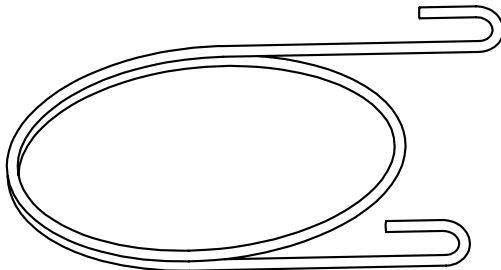

COLLAR FOR SQUARE POST

POLE	MATERIAL	CODE
8x8.5	STAINLESS STEEL Ø4	309 10 003

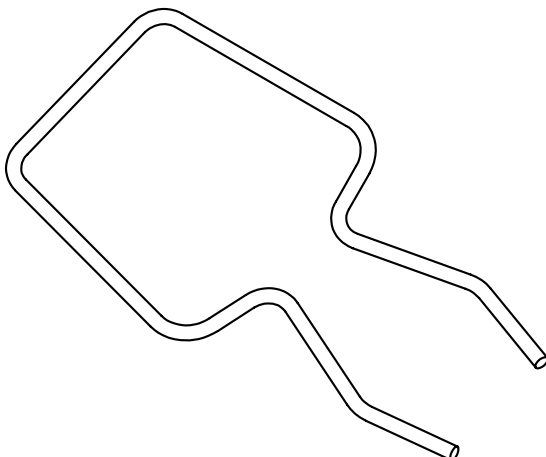

COLLARS AND BANDS

CHAIN CLAMP COLLAR

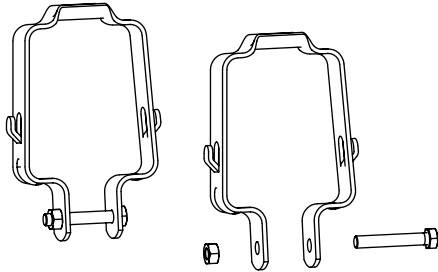

ØPOLE	MATERIAL	CODE
9x8	STEEL +	000 13 012
9x9	HOT DIPPED GALVANIZED	000 10 015

CHAIN TENSIONER

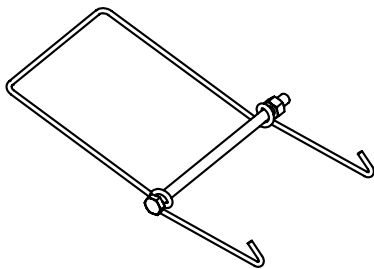

Ø	MATERIAL	CODE
2.80	STAINLESS STEEL	275 06 002

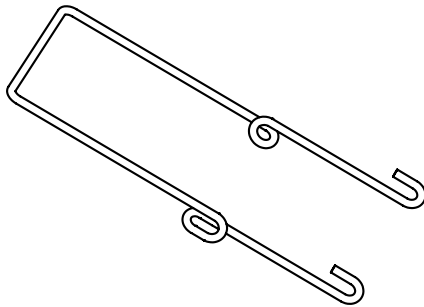

Ø	MATERIAL	CODE
3.50	STAINLESS STEEL	181 19 003

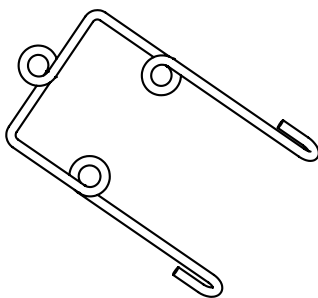

Ø	MATERIAL	CODE
3.50	STAINLESS STEEL	181 19 004

BAND FOR STRAIGHT POST

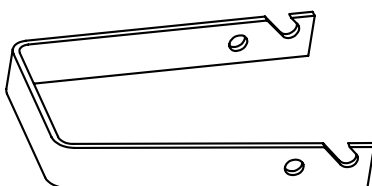

POLE	MATERIAL	CODE
7x7	STAINLESS STEEL	000 05 013
8x8		000 05 031
9x9		000 05 011

COLLARS AND BANDS

WIRE TENSIONER

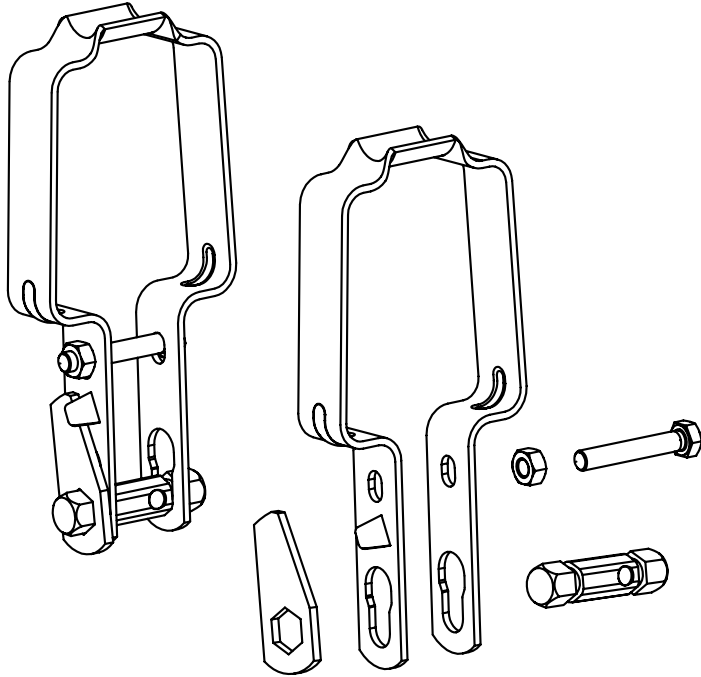

POLE	MATERIAL	CODE
8x8.5	STEEL + HOT DIPPED GALVANIZED	000 18 015
9x8		000 09 014
9x9		000 07 004
9x9.5		000 18 016
10x12		000 09 002
10x12(CORTO)		000 09 402

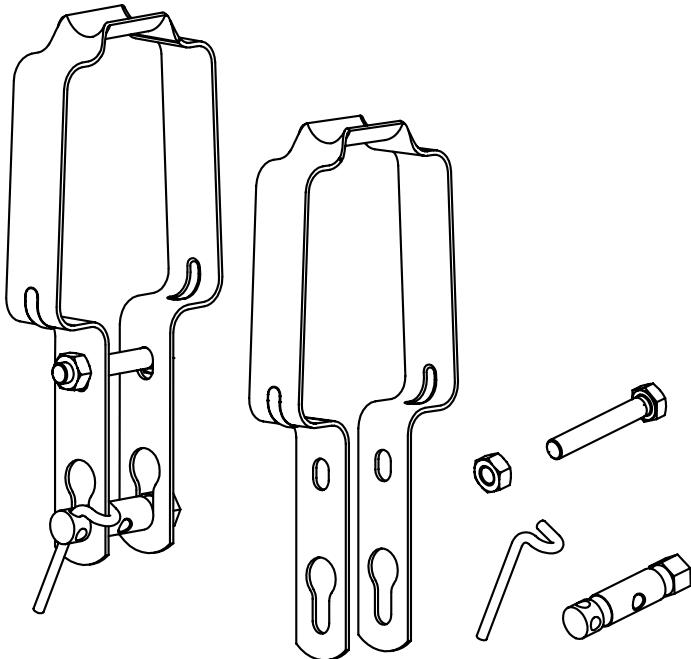

POLE	MATERIAL	CODE
9x8	STAINLESS STEEL	000 09 214
9x9		000 07 304
10x12		000 09 202

COLLARS AND BANDS

BAND FOR CONCRETE POST

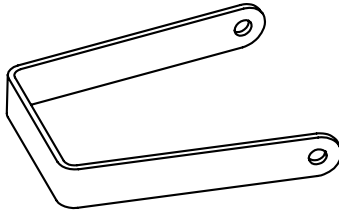

POLE	MATERIAL	CODE
7x7	STAINLESS STEEL	000 05 033
8x8		000 05 012
9x9		000 09 034

BAND FOR CONCRETE POST

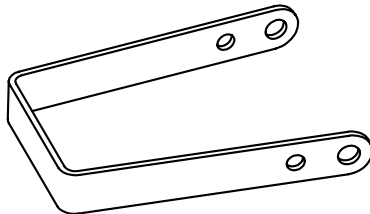

POLE	MATERIAL	CODE
7x7	STAINLESS STEEL	000 05 030
9x9		000 05 130

BAND FOR CONCRETE POST

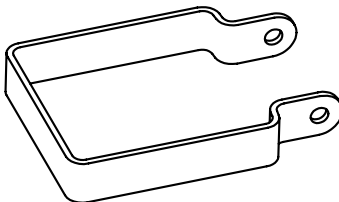

POLE	MATERIAL	CODE
7x7	STAINLESS STEEL	000 05 034
8x8		000 05 035
9x9		000 05 036

SEPARATE BAND FOR CONCRETE POST

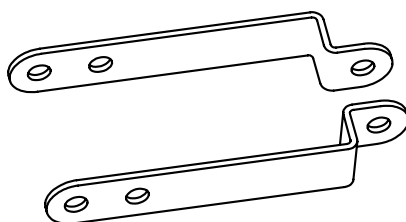

POLE	MATERIAL	CODE
7x7	STAINLESS STEEL	000 05 015
8x8		000 05 115
9x9		000 05 215

COLLARS AND BANDS

COLLAR FOR CONCRETE INCLINED POST

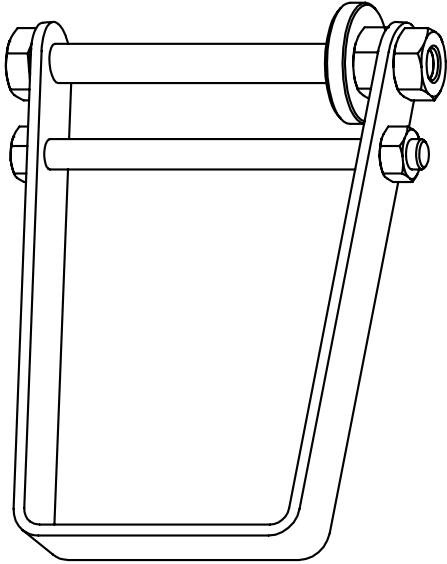

POLE	MATERIAL	CODE
7x7	STAINLESS STEEL	000 05 330
9x9		000 05 230

DOUBLE COLLAR FOR CONCRETE POST 7X7 AND 9X9

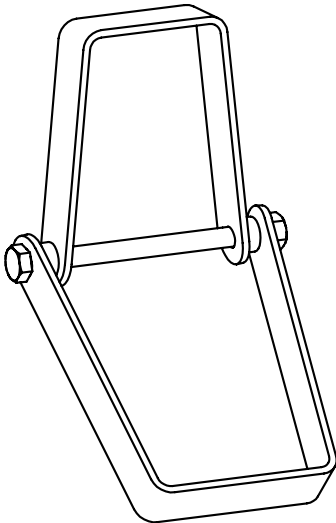

MATERIAL	CODE
STAINLESS STEEL	000 05 051

ANCHORS

TIGHTENING HOOK "LIGHT"

MATERIAL	CODE
STEEL + HOT DIPPED GALVANIZED	000 03 002

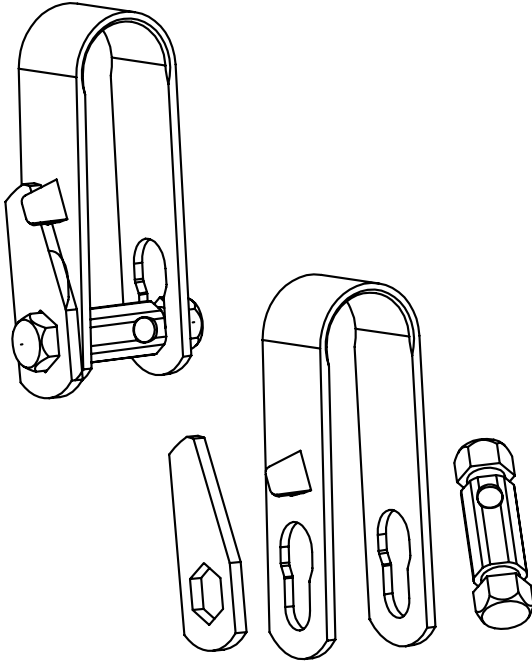

MATERIAL	CODE
STAINLESS STEEL	000 03 402

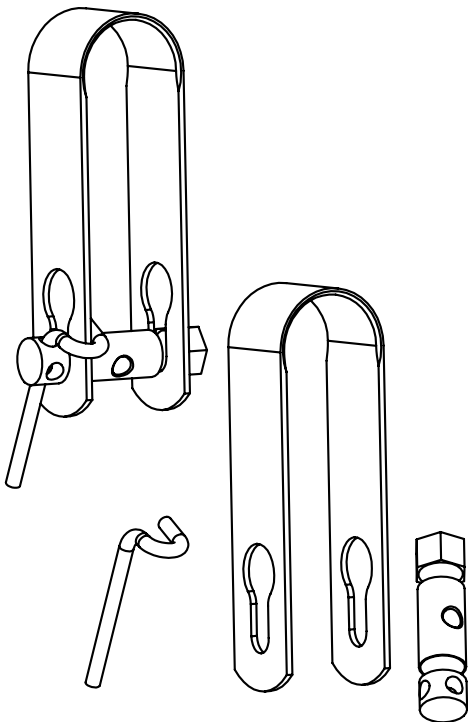

ANCHORS

DOUBLE TIGHTENING HOOK

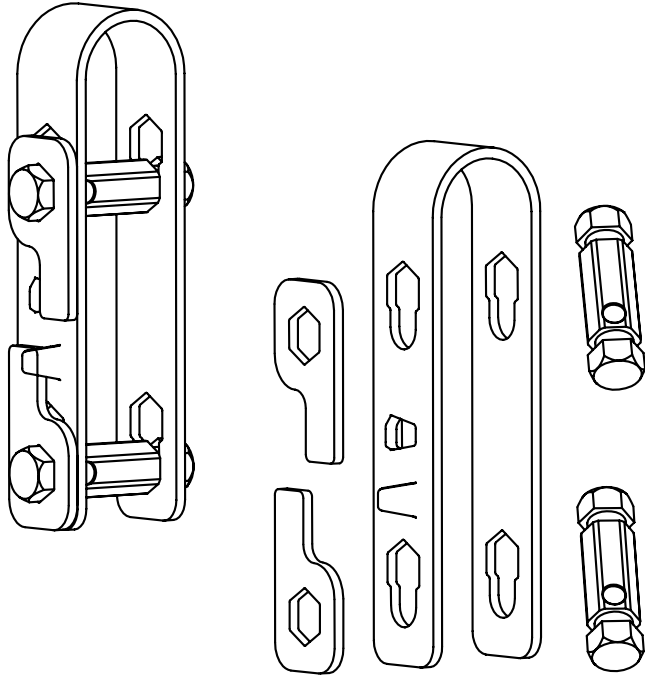

MATERIAL	CODE
STEEL + HOT DIP. GALVAN. 2 PIVOTS 2	000 09 001
STEEL + HOT DIP. GALVAN. 1 PIVOT 1 PLATE	000 09 501

SINGLE TIGHTENING HOOK

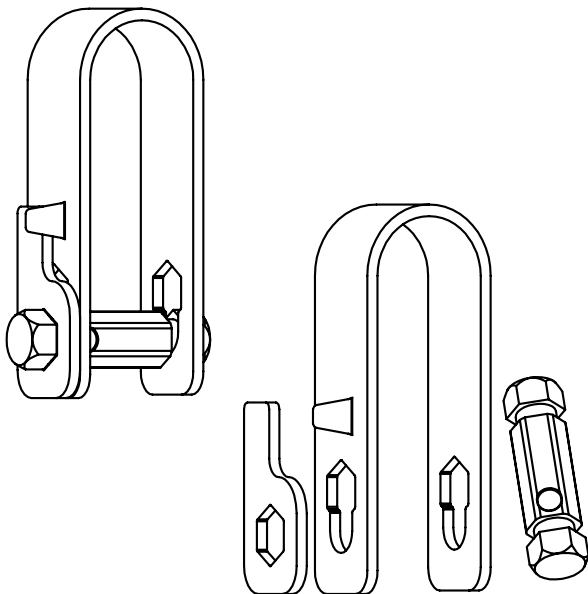

MATERIAL	CODE
STEEL + HOT DIP. GALVAN. 1 PIVOT 1 PLATE	000 12 515

ANCHORS

DOUBLE TIGHTENING HOOK

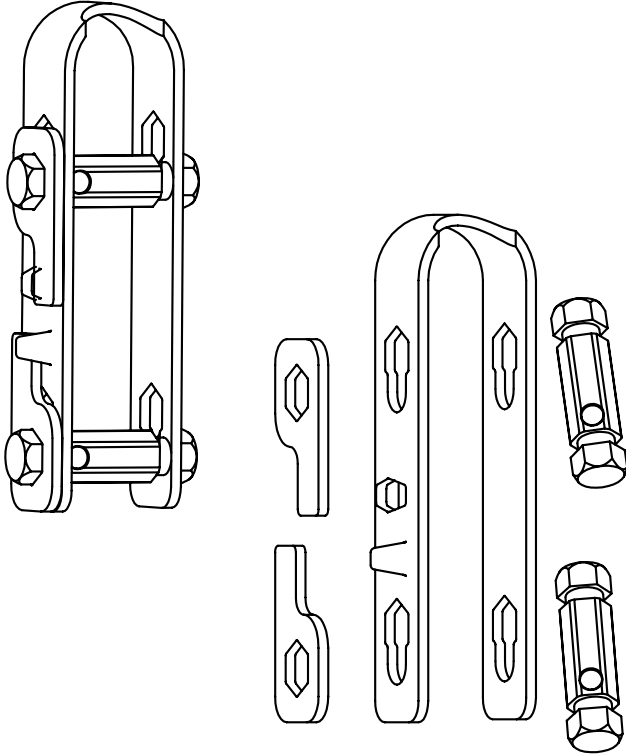

MATERIAL	CODE
STEEL + HOT DIP. GALVAN. 2 PIVOTS 2 PLATES	000 09 401
STEEL + HOT DIP. GALVAN. 1 PIVOT 1 PLATE	000 09 601

SINGLE TIGHTENING

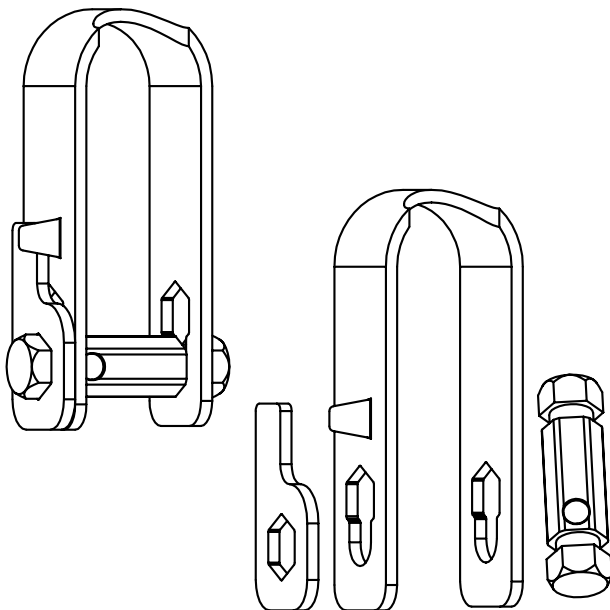

MATERIAL	CODE
STEEL + HOT DIP. GALVAN. 1 PIVOT 1 PLATE	000 12 015

U-BOLTS

ROUND U-BOLT, WITH OR WITHOUT NUTS - DIMENSION ON REQUEST

MATERIAL

CODE

CRAPAL / GALVANIZED STEEL

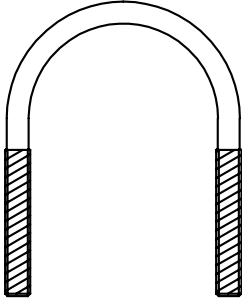

TRAPEZOIDAL U-BOLT, WITH OR WITHOUT NUTS - DIMENSION ON REQUEST

MATERIAL

CODE

CRAPAL / GALVANIZED STEEL

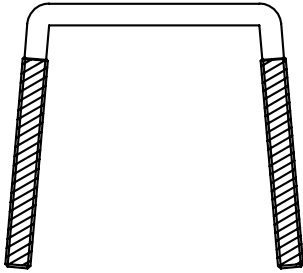

SQUARE U-BOLT WITH OR WITHOUT NUTS - DIMENSION ON REQUEST

MATERIAL

CODE

CRAPAL / GALVANIZED STEEL

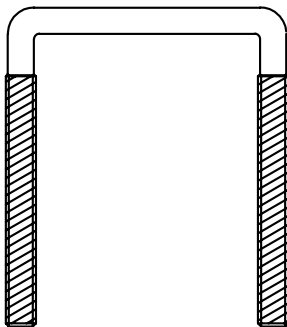

ANTI-SINKING PLATES

ANTI-SINKING PLATES (COUPLE INCLUDED FASTENERS AND NUTS M10)

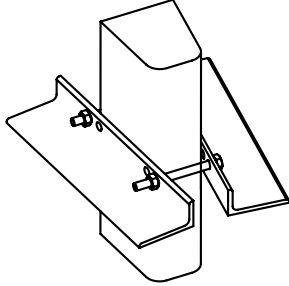

TYPE	POLE	OUTLINE	MATERIAL	CODE
4 HOLES	10x12	80x40x6	STEEL RAW	000 18 017
			STEEL + HOT DIPPED GALVA.	000 18 217

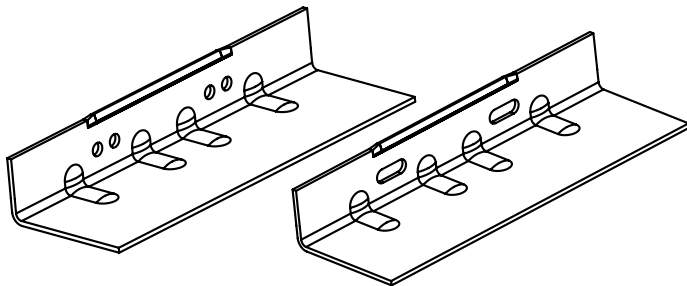

TYPE	OUTLINE	MATERIAL	CODE
HOLES	330x107x53	GALVANIZED	000 19 001
LOOP	330x107x53	GALVANIZED	000 19 004

HEADER PLATE (PROFIL ALSACE ROUND POST)

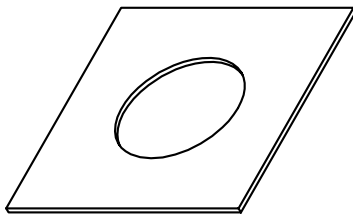

MATERIAL	CODE
GALVANIZED STEEL	113 06 001

ANTI-SINKING SINGLE PLATE - MODEL P

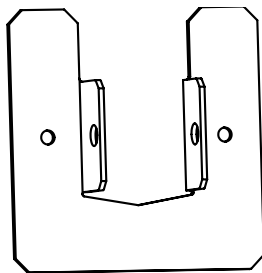

POLE	SIZE	MATERIAL	CODE
60x68	150x150	RAW	000 18 008
60x68		STEEL + HOT DIPPED GALVA.	000 18 108
60x68		CORTEN	000 18 208
60x68		ELECTROLYT.	000 18 308

ANTI-SINKING SINGLE PLATE - MODEL M

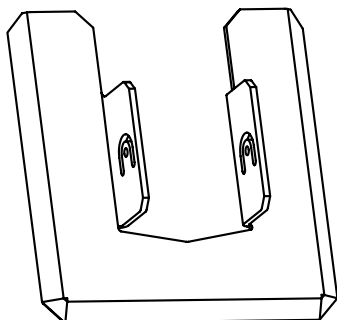

POLE	SIZE	MATERIAL	CODE
60x68	150x150	RAW	000 18 011
60x68		STEEL + HOT DIPPED GALVA.	000 18 111
60x68		CORTEN	000 18 211
60x68		ELECTROLYT.	000 18 311

STAINLESS STEEL WIRE

WIRE



Ø	MATERIAL	CODE
1.00	STAINLESS STEEL 1.4301 (AISI 304)	
1.20		
1.40		
1.60		
1.80		
2.00		

Ø	MATERIAL	CODE
3.00	STAIN. STEEL 1.4301 (AISI 304)	