



Accessori per vigneti & frutteti



Indice

GANCI PER TUTORI - LEGATRALCI	PAG.1-5
ACCESSORI VARI	PAG.6-12
MENSOLE E SUPPORTI	PAG.13-14
MOLLE DISTANZIATICI	PAG.15-16
COLLARI E FASCE	PAG.17-22
ANCORAGGI	PAG.23-25
CAVALLOTTI	PAG.26
PIASTRA ANTI-SFONDAMENTO	PAG.27
FILO INOX	PAG.28

GANCI PER TUTORI-LEGATRALCI

LAGATRALCIO

DIMENSIONE	Ø	MATERIALE	COD.
L75	1.60	INOX	000 01 014
L100	1.60		115 99 005

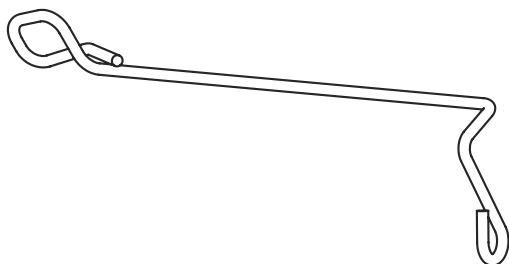
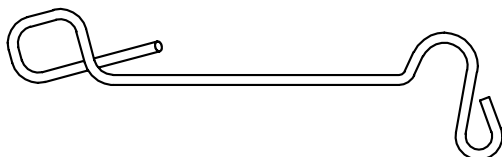

DIMENSIONE	Ø	MATERIALE	COD.
L96	1.80	INOX	000 03 005

LAGATRALCIO VENDEMMIA MECCANIZZATA

DIMENSIONE	Ø	MATERIALE	COD.
L95	1.60	INOX	171 06 002

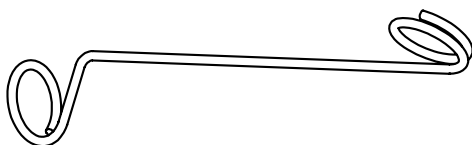

LAGATRALCIO PIEGATO CON DOPPIO RICCIOLO

DIMENSIONE	Ø	MATERIALE	COD.
L80	1.60	INOX	000 04 013
L100	1.60		000 04 314
L100	1.80		000 04 114

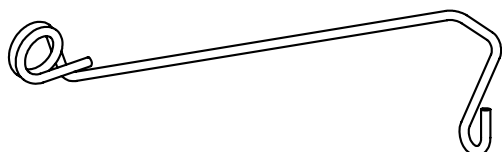

GANCIO PER CANNE VENDEMMIA MECCANIZZATA

DIMENSIONE	Ø	MATERIALE	COD.
L110	2.00	INOX	171 06 005
L110	2.00	ACCIAIO ZINCATO	171 06 105

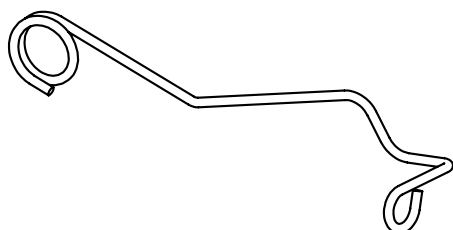

GANCI PER TUTORI-LEGATRALCI

GANCIO FERMACANNE

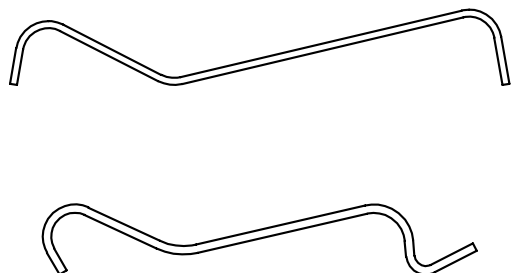

DIMENSIONE	Ø	MATERIALE	COD.
L112	2.50	ACCIAIO ZINCATO	000 99 006
L145	3.00	ACCIAIO ZINCATO	000 03 114
L145	3.00	INOX	000 03 214
L178	3.00	ACCIAIO ZINCATO	000 03 012
L178	3.00	INOX	000 03 212
L215	3.00	ACCIAIO ZINCATO	000 03 013

DIMENSIONE	Ø	MATERIALE	COD.
L155	3.00	ACCIAIO ZINCATO	245 08 106

GANCIO FERMACANNE ANTISGANCIO

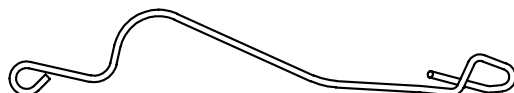

DIMENSIONE	Ø	MATERIALE	COD.
L160	2.00	ACCIAIO ZINCATO	000 02 020
L160	2.00	INOX	000 02 120
L160	2.50	ACCIAIO ZINCATO	000 02 022
L160	2.50	INOX	000 02 122

GANCIO FERMACANNE ANTISGANCIO CON DOPPIO RICCIOLO



DIMENSIONE	Ø	MATERIALE	COD.
L150	2.00	ACCIAIO ZINCATO	171 02 002
L150	2.00	INOX	171 02 102
L150	2.50	ACCIAIO ZINCATO	171 04 001
L150	2.50	INOX	171 04 101
L245	2.50	ACCIAIO ZINCATO	169 08 001
L245	2.50	INOX	169 08 101

GANCIO PER TUTORE TIPO L

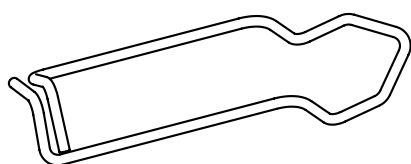

DIM.CANNE	Ø	MATERIALE	COD.
6-10	1.60	INOX	000 05 027
6-10	1.60	ACCIAIO ZINCATO	000 05 127
6-10	1.60	EXTRALEGA	000 05 227
10-16	1.60	INOX	000 05 028
10-16	1.60	ACCIAIO ZINCATO	000 05 128
10-16	1.60	EXTRALEGA	000 05 228
6-10	1.70	INOX	000 18 024

GANCI PER TUTORI-LEGATRALCI

STABFIX

DIMENSIONE	Ø	MATERIALE	COD.
L80	2.00	ACCIAIO ZINCATO	169 06 001

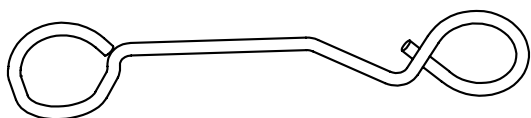

GANCIO FERMACANNE RAPIDO

DIM.CANNE	Ø	MATERIALE	COD.
6-10	1.60	INOX	000 05 017
10-16	1.60		000 10 001
16-20	1.60		000 10 002
20-26	1.60		000 10 003

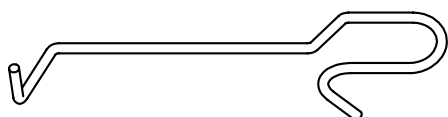

MAT. ZINCATO
A RICHIESTA

GANCIO GERMACANNE TOP

DIMENSIONE	Ø	MATERIALE	COD.
6-10	2.00	ACCIAIO ZINCATO	000 17 019

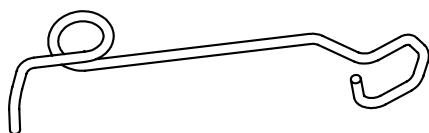

STANFIX

DIMENSIONE	Ø	MATERIALE	COD.
L90	2.00	ACCIAIO ZINCATO	194 06 004

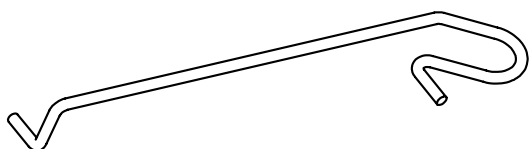

GANCIO BLOCCAGGIO PER TUTORI

DIMENSIONE	Ø	MATERIALE	COD.
L65	2.00	INOX	171 02 001
L80	2.00		171 02 003

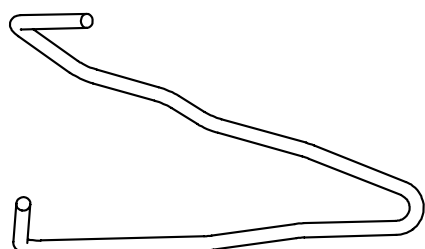

GANCI PER TUTORI-LEGATRALCI

PFAHLFIX

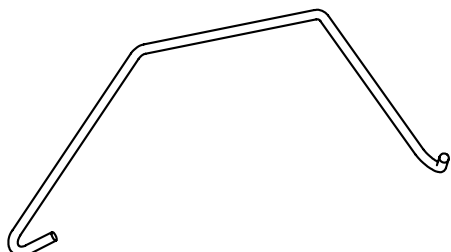

PALO	Ø	MATERIALE	COD.
5x5	3.00	ACCIAIO ZINCATO	169 09 005
6x6			169 09 006
7x7			169 05 003
7x8			169 09 008
8x8			169 09 003
8x8.5			000 10 022
9x9			000 09 015
9x9.5			000 17 006
10x12			000 17 007

BOUNDFIX

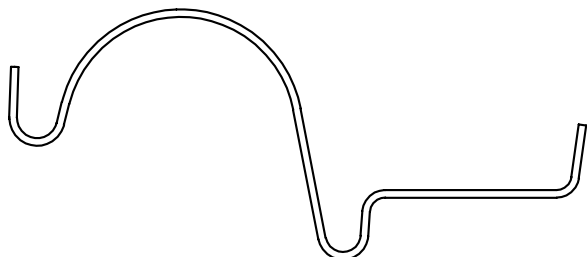

PALO	Ø	MATERIALE	COD.
6x6	3.00	ACCIAIO ZINCATO	175 07 001
6.5x6.5			175 07 002
7x7			175 06 003
7x8			175 06 001
8x8			116 06 003
8.5x8.5			231 09 002
9x9			231 09 001
9.5x9			169 07 001

PLANTFIX

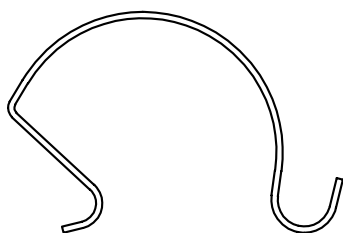

TIPO	Ø	MATERIALE	COD.
50	2.00	ACCIAIO ZINCATO	169 02 009
70	2.50		169 02 007
120	2.50		169 04 001

GANCIO PER KIWI

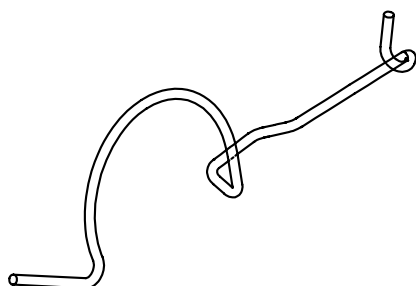

Ø	MATERIALE	COD.
2.00	INOX	000 06 015

GANCI PER TUTORI-LEGATRALCI

SAULENFIX

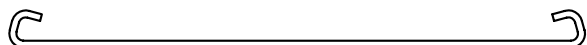

TIPO	Ø	LUNGH.	MATERIALE	COD.
7x7	3.00	247	ACCIAIO ZINCATO	000 13 006
8x8	3.00	280		000 13 007
9x9	3.00	300		000 13 008

GANCIO FERMAFILO



Ø	MATERIALE	COD.
3.00	ACCIAIO ZINCATO	169 04 002

BAMBUGEL

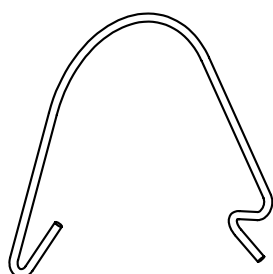
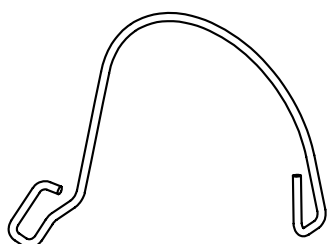
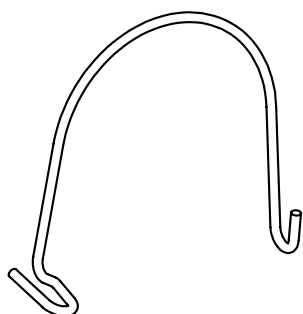

Ø	MATERIALE	COD.
3.00	ACCIAIO ZINCATO	169 03 007

TIPO	Ø	ØPIANTA	MATERIALE	COD.
NORM.	2.50	FINO Ø70	ACCIAIO ZINCATO	169 05 002
XL	2.50	DOPO Ø70		169 10 001

Ø	MATERIALE	COD.
2.50	ACCIAIO ZINCATO	175 06 002

ACCESSORI VARI

ARPETTA

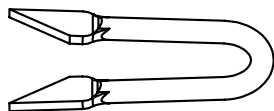

DIMENSIONE	Ø	MATERIALE	COD.
CORTA 35mm	3.00	INOX	171 07 017
LUNGA 50mm	3.00		171 07 021

ARPETTA ARPIONATA



Ø	MATERIALE	COD.
4.00	CRAPAL	000 06 004

CHIODO DISTANZIATORE

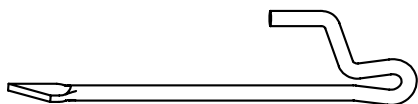

Ø	MATERIALE	COD.
3.00	INOX	171 07 010

CHIODO FERMACATENA

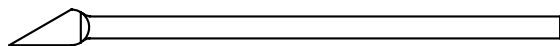

DIMENSIONE	Ø	MATERIALE	COD.
L100	4.00	INOX	171 07 022

GANCIO PORTAFILO PER PALO TONDO



Ø	MATERIALE	COD.
2.5	INOX	381 08 006

Ø	MATERIALE	COD.
2.5	INOX	461 16 001

ACCESSORI VARI

GANCIO TENDITORE "GRILLO"

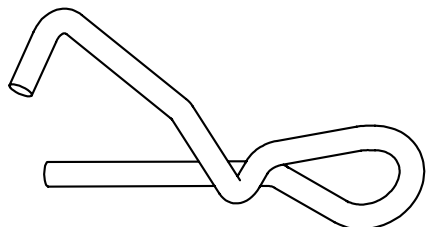

Ø	MATERIALE	COD.
5.20	CRAPAL	115 02 101

TENDIFILO

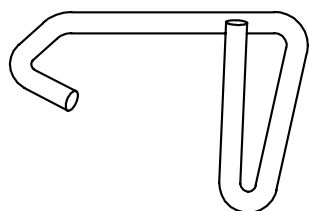

Ø	MATERIALE	COD.
5.00	INOX	171 07 013

MOLLA A TRAZIONE

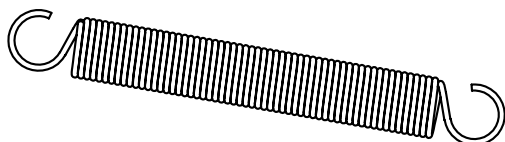

DIMENSIONE	Ø	MATERIALE	COD.
L180	2.50	ACCIAIO ZINCATO	000 09 017

GANCETTO A "S"

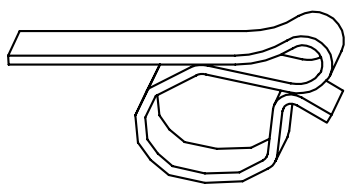

NASTRO	MATERIALE	COD.
7x1	INOX	000 05 010

COPIGLIA

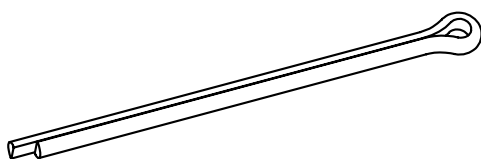

DIMENSIONE	MATERIALE	COD.
L100	Fe ZINCATO A CALDO	259 09 002
L100	INOX	259 09 102

ACCESSORI VARI

RULLINO TENDIFILO E FERMO PER RULLINO

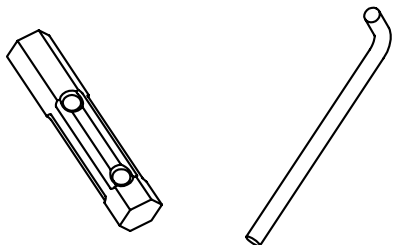

COMPONENTI	MATERIALE	COD.
RULLINO ESAG. TRF 13	INOX	245 08 004
FERMO PER RULLINO Ø5		171 07 012

ESAGONO PER PALO DI TESTATA

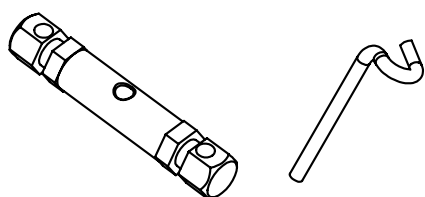

COMPONENTI	MATERIALE	COD.
PERNO ESAG. TRF 13	INOX	000 15 005
FERMO PER RULLINO Ø4		171 06 011

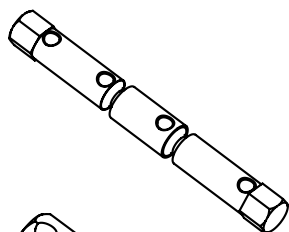

COMPONENTI	MATERIALE	COD.
PERNO ESAG. TRF 13	INOX	000 13 002
FERMO PER RULLINO Ø4		171 06 011

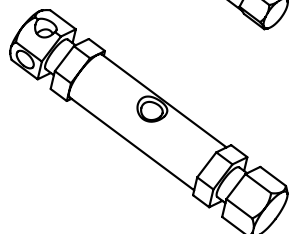

COMPONENTI	MATERIALE	COD.
PERNO ESAG. TRF 13	INOX	000 17 110
FERMO PER RULLINO Ø4		171 06 011

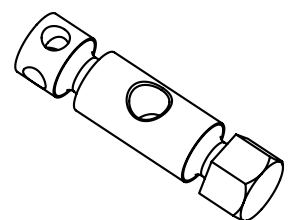

COMPONENTI	MATERIALE	COD.
PERNO ESAG. TRF 13	Fe	000 08 008
FERMO PER RULLINO Ø4		171 06 011

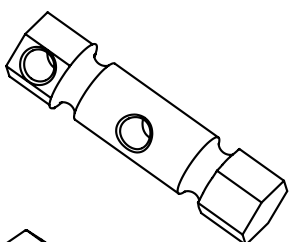

COMPONENTI	MATERIALE	COD.
PERNO ESAG. TRF 11	INOX	000 08 015
FERMO PER RULLINO Ø4		171 06 011

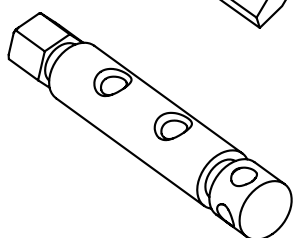

COMPONENTI	MATERIALE	COD.
PERNO ESAG. TRF 15	Fe	000 17 011
FERMO PER RULLINO Ø4		171 06 011

ACCESSORI VARI

CAMBRETTA PER PALO CEMENTO

Ø	MATERIALE	COD.
3.50	INOX	000 09 020

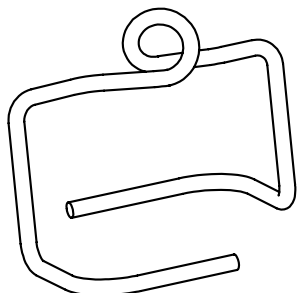

MOLLA PER COPRIPALO 2 OCCHIELLI

Ø	MATERIALE	COD.
2.50	INOX	203 16 001

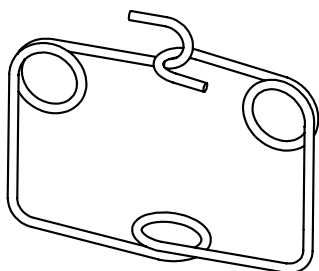

ACCESSORI VARI

GANCIO DOPPIO PER RETI

DIMENSIONE	Ø	MATERIALE	COD.
L55	3.00	Fe ZINCATO	043 97 003

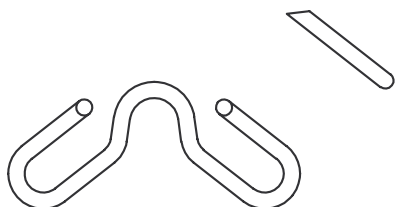

AGO FERMARETE

DIMENSIONE	Ø	MATERIALE	COD.
L180	2.50	ACCIAIO ZINCATO	000 04 009
L180	2.50	INOX	000 04 109

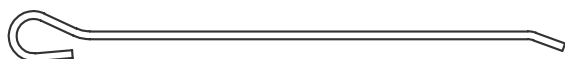

ANELLO PER RETE ANTI-GRANDINE

Ø	ØINT	MATERIALE	COD.
8.00	70	Fe ZINCATO	000 09 005
8.00	70	Fe ZINCATO A CALDO	000 09 105
8.00	90	Fe ZINCATO	000 10 035
8.00	90	Fe ZINCATO A CALDO	000 10 135

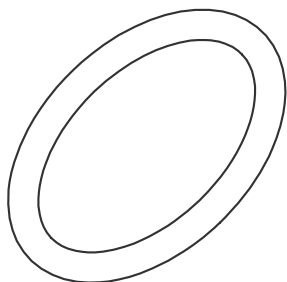

ACCESSORI VARI

TUBO PER IRRIGAZIONE

DIMENSIONE	Ø	MATERIALE	COD.
L 152	2.00	INOX	381 08 004



GANCIO PER FILI PARALLELI

DIMENSIONE	Ø	MATERIALE	COD.
L 56	2.50	INOX	000 09 016

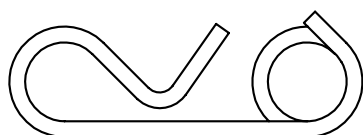

STAFFA FERMA FUNE LEGGERA M8 STAFFA FERMA FUNE PESANTE M10

TIPO	SP.	LUNGH.	MATERIALE	COD.
M8	4.5	120	ACCIAIO ZINC	169 10 007
M8	3.5	145	ACCIAIO ZINC	169 05 101
M8	3.5	145	Fe ZIN CALDO	169 05 201
M8	4.5	180	ACCIAIO ZINC	169 10 008

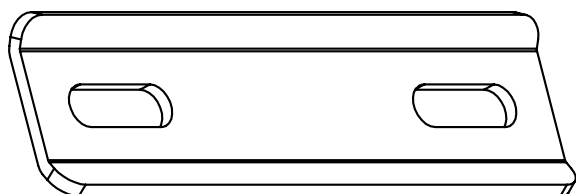

TIPO	SP.	LUNGH.	MATERIALE	COD.
M10	4.5	120	ACCIAIO ZINC	169 10 107
M10	3.5	145	ACCIAIO ZINC	169 05 301

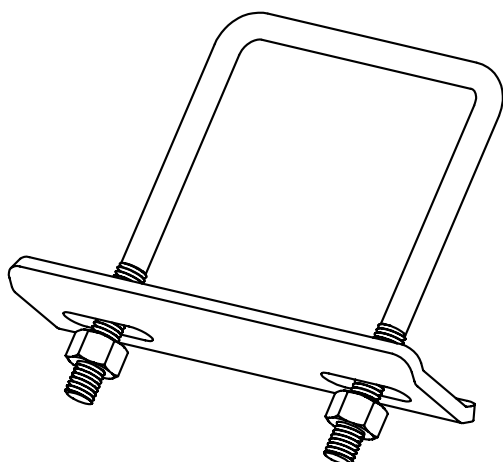

N.B. : solo su richiesta tutte le staffe possono essere fornite con cavallotti

ACCESSORI VARI

CATENELLE CRAPAL 7 MAGLIE (LUNGHEZZA 22CM)

Ø	MATERIALE	COD.
3.10	CRAPAL	000 03 016

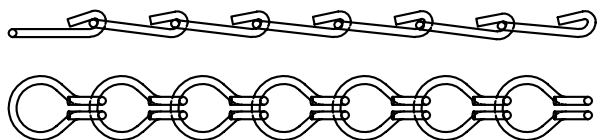

CATENELLA INOX 24x8

Ø	MATERIALE	COD.
2.40	INOX	000 07 200

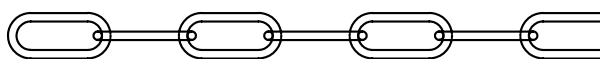

SOSTEGNO PER CATENELLE PER PALI PROFIL ALSACE

Ø	MATERIALE	COD.
3.00	INOX	000 99 010
4.00		000 99 110



CAVALLOTTO PER CATENELLA PER PALI PROFIL ALSACE

Ø	MATERIALE	COD.
4.00	INOX	169 02 105
5.00		169 02 005

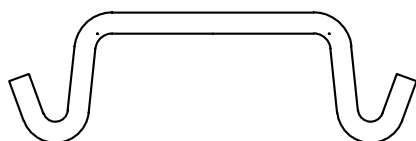

COLLARE PER CATENELLA

Ø	MATERIALE	COD.
5.00	INOX	000 09 013

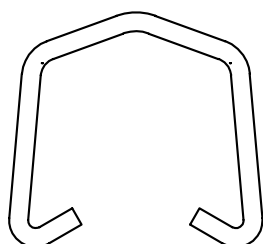

MENSOLE E SUPPORTI

MENSOLA APRIFILO (MISURE A RICHIESTA)

Ø	MATERIALE	COD.
2.80	INOX	

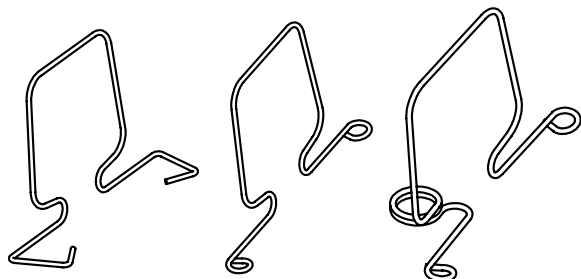

MENSOLA FISSA APRIFILO

PALO	Ø	MATERIALE	COD.
7x7	2.80	INOX	000 99 003
8x8	2.80		000 99 004
9x9	2.80		000 99 005



MENSOLA APRIFILO IN NASTRO

LUNGHEZZA	MATERIALE	COD.
200	ACCIAIO ZINCATO CALDO	000 05 002
250	ACCIAIO ZINCATO CALDO	000 05 029



MENSOLE E SUPPORTI

MOLLA PALO CEMENTO

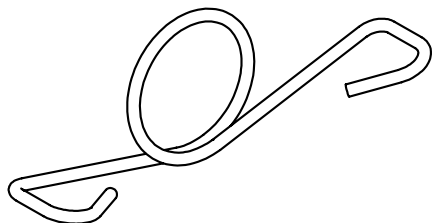

ØPALO	Ø	MATERIALE	COD.
5x5	60	ACCIAIO ZINCATO Ø3.50	169 02 002
6x6	70		169 02 003
7x7	80		169 02 004

BRACCETTO FUSAXE

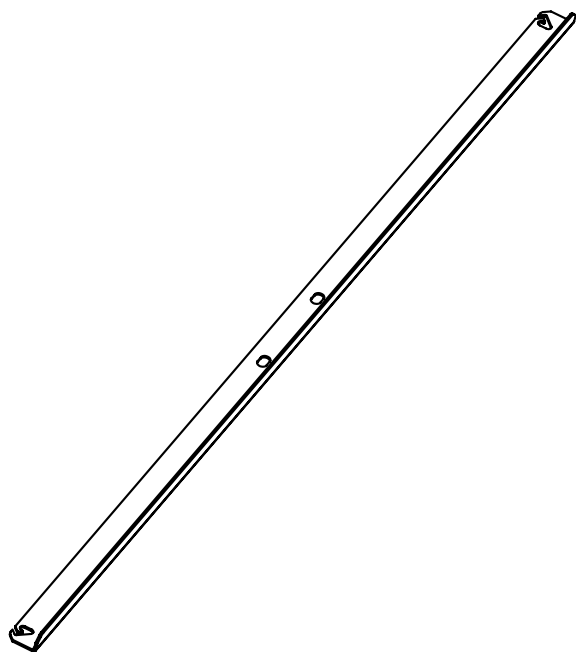

LUNGH.	SP.	MATERIALE	COD.
250	1.50	ACCIAIO ZINCATO	169 10 002
400	1.50		169 03 008
600	1.50		169 03 001
600	2.00		169 03 301
600	3.00		169 03 201
800	1.50		169 03 002
800	2.00		169 03 102
800	3.00		169 03 202
1000	2.00		169 03 009

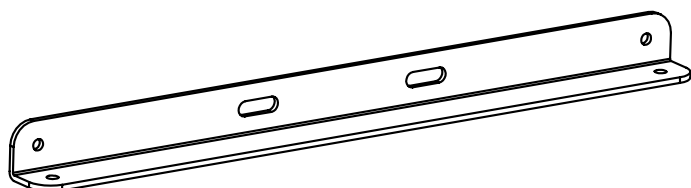

LUNGH.	SP.	MATERIALE	COD.
350	3.00	ACCIAIO ZINCATO	000 10 029
400	3.00		000 12 003
450	3.00		000 10 014
550	3.00		000 10 030

MOLLE DISTANZIATRICI

DISTANZIATORE PALO FERRO CON/SENZA GANCIO DI CHIUSURA.
MISURE A RICHIESTA.

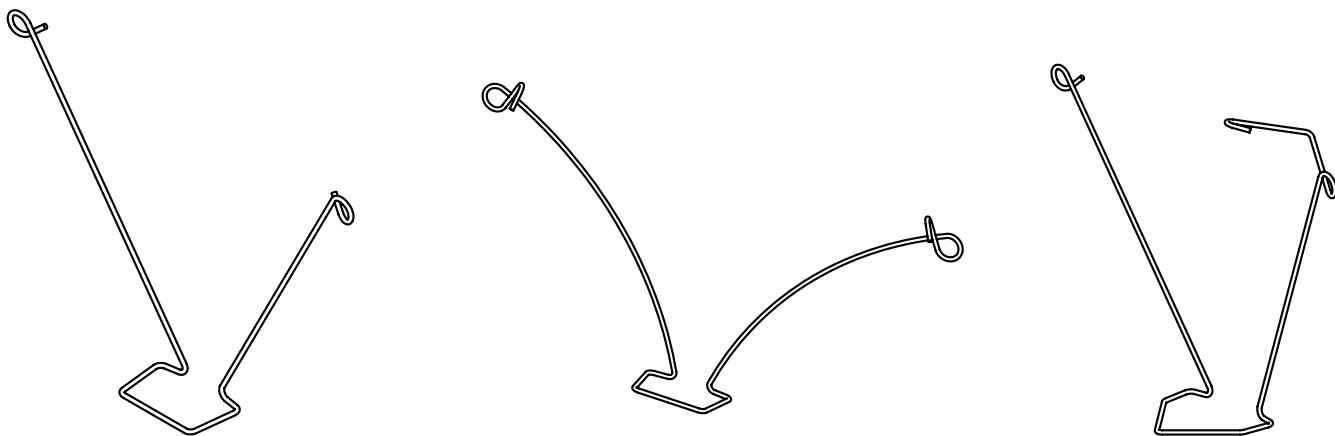

DISTANZIATORE PALO CEMENTO TIPO LAMPO CON GANCIO DI CHIUSURA.
MISURE A RICHIESTA

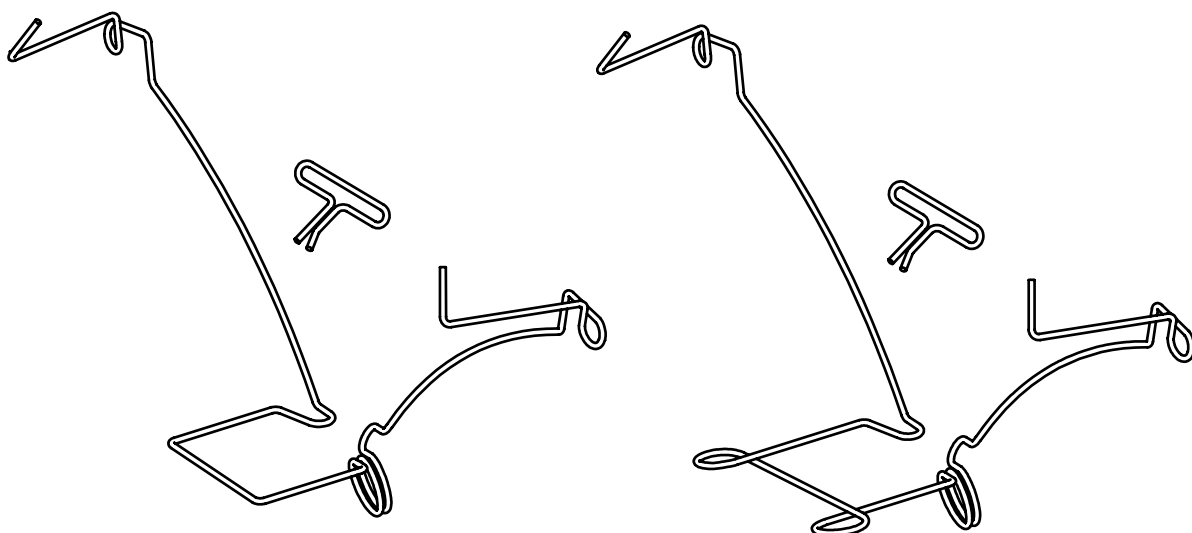

MOLLE DISTANZIATRICI

DISTANZIATORE PALO LEGNO 1 O 2 OCCHIELLI

Ø	MAT.	COD.
2.50	INOX	000 99 027
2.50		000 99 052

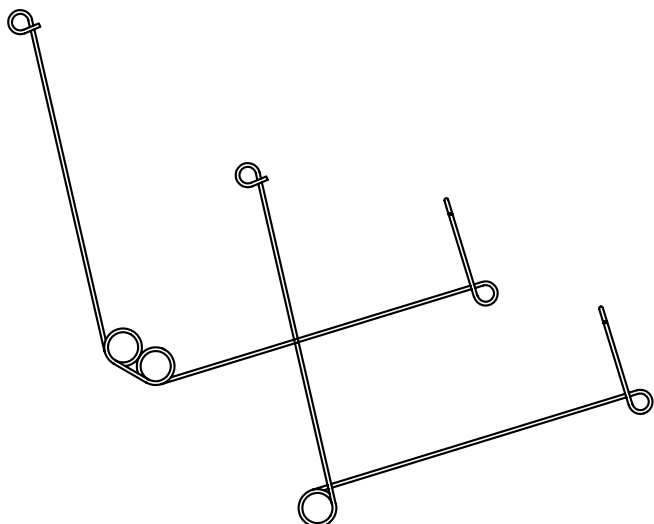

DISTANZIATORE PALO LEGNO TONDO CON/SENZA GANCIO DI CHIUSURA

Ø	MAT.	COD.
2.50	INOX	

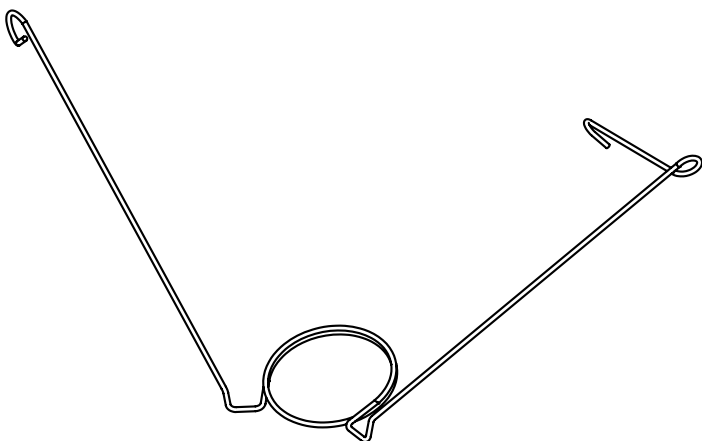

COLLARI E FASCE

COLLARE DOPPIOGIRO PER PALO TONDO

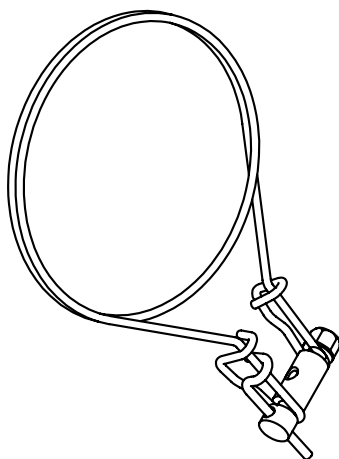

ØPALO	MATERIALE	COD.
10	INOX	171 08 502
12		171 06 507
14		171 06 514
16		171 06 515

FASCE PER PALO TONDO DA 8.5 A 12

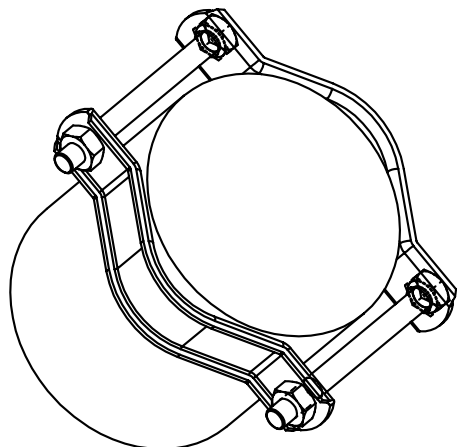

MATERIALE	COD.
ACCIAIO ZINCATO A CALDO	000 06 119
ACCIAIO ZINCATO A CALDO (NO DADI E VITI)	000 06 019

COLLARE PER PALO SEZIONE QUADRA

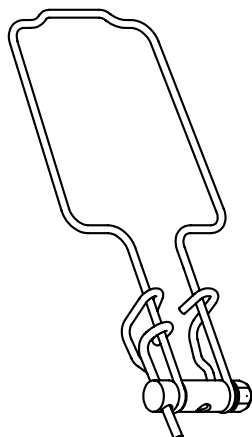

PALO	Ø	MATERIALE	COD.
5x5	4.00	INOX	171 11 503
8x9	4.00		171 07 516

COLLARI E FASCE

GANCIO PER TIRANTE

Ø	MAT.	COD.
4.00	INOX	171 07 514

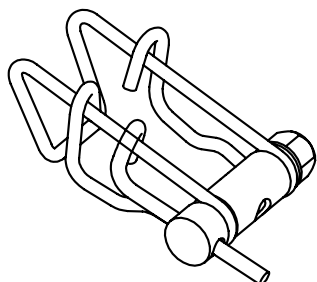

COLLARE CATENELLA PER PALO TONDO

ØPALO	MATERIALE	COD.
10	INOX Ø2.8	201 10 001
12		201 10 002

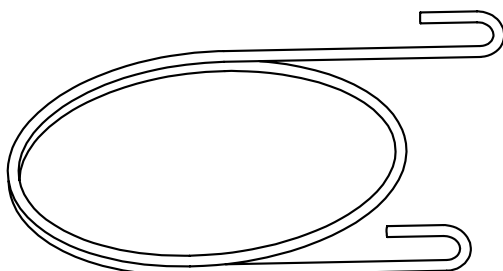

COLLARE DI SPINTA PER PALO QUADRO

PALO	MATERIALE	COD.
8x8.5	INOX Ø4	309 10 003

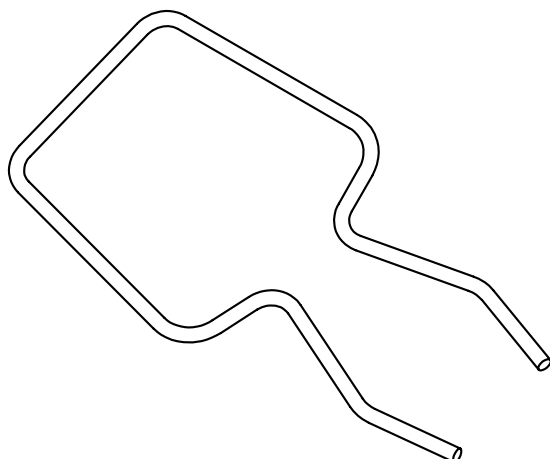

COLLARI E FASCE

COLLARE FERMACATENA

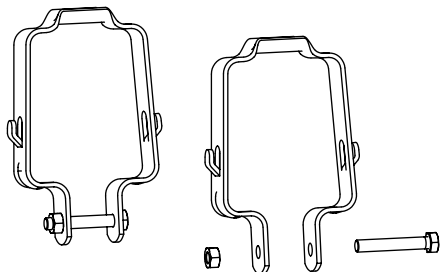

ØPALO	MATERIALE	COD.
9x8	Fe ZINCATO A CALDO	000 13 012
9x9		000 10 015

COLLARE TENDICATENA

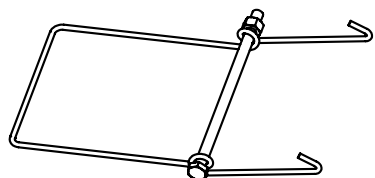

Ø	MAT.	COD.
2.80	INOX	275 06 002

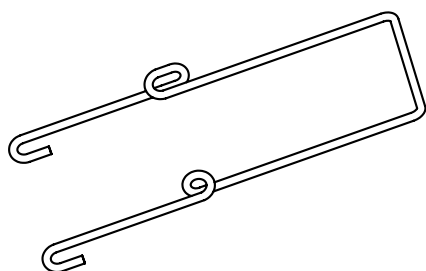

Ø	MAT.	COD.
3.50	INOX	181 19 003

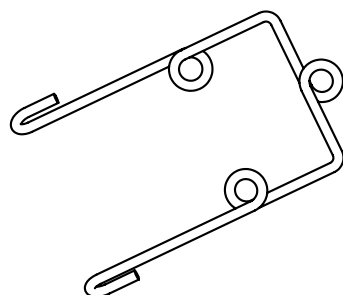

Ø	MAT.	COD.
3.50	INOX	181 19 004

FASCIA PER PALO DIRITTO

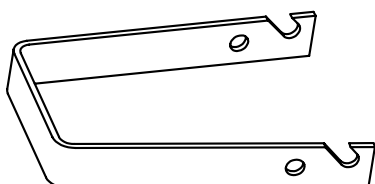

PALO	MATERIALE	COD.
7x7	INOX	000 05 013
8x8		000 05 031
9x9		000 05 011

COLLARI E FASCE

COLLARE TENDIFILO

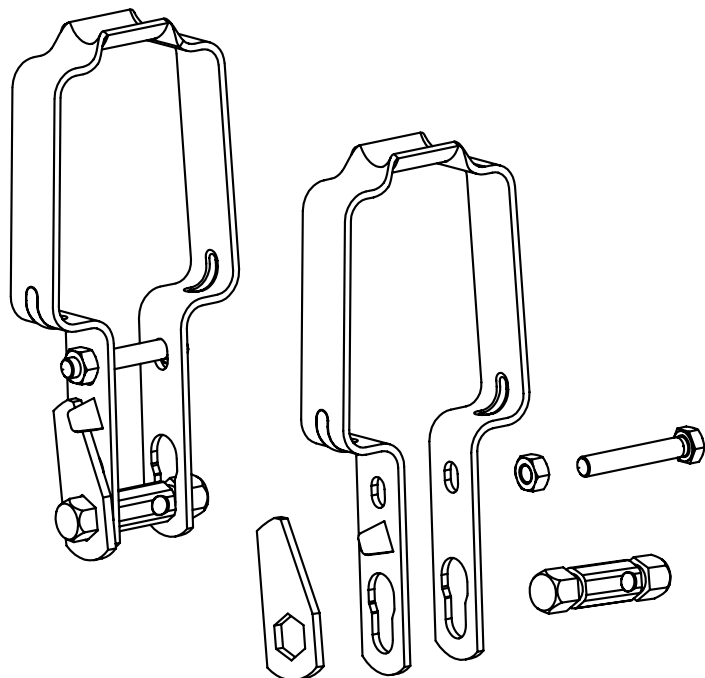

PALO	MATERIALE	COD.
8x8.5	Fe ZINCATO A CALDO	000 18 015
9x8		000 09 014
9x9		000 07 004
9x9.5		000 18 016
10x12		000 09 002
10x12(CORTO)		000 09 402

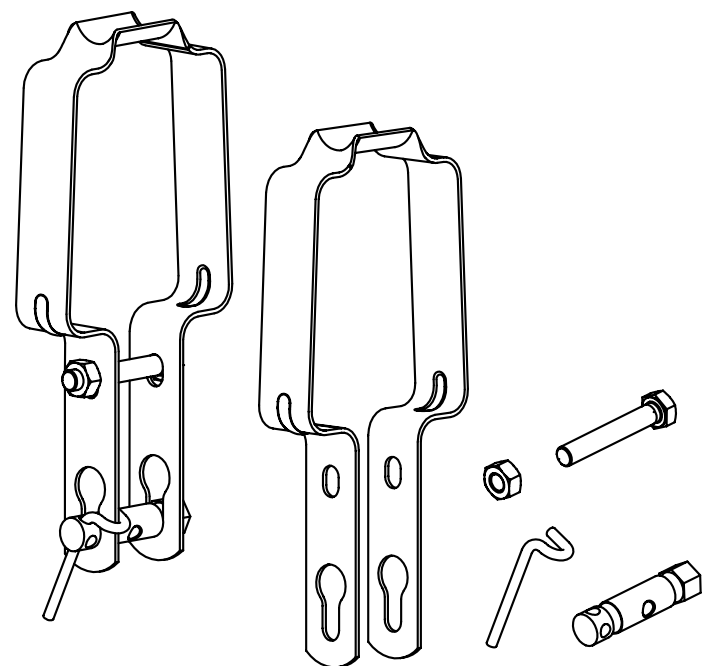

PALO	MATERIALE	COD.
9x8	INOX	000 09 214
9x9		000 07 304
10x12		000 09 202

COLLARI E FASCE

FASCIA PER PALO INCLINATO

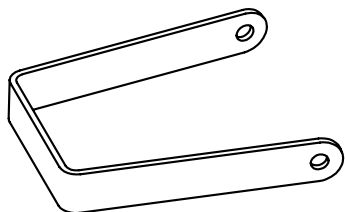

PALO	MATERIALE	COD.
7x7	INOX	000 05 033
8x8		000 05 012
9x9		000 09 034

FASCIA PER PALO INCLINATO CON DOPPIO FORO

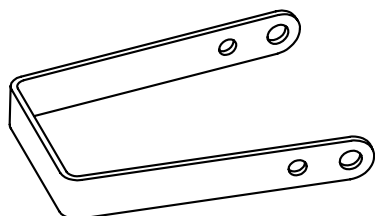

PALO	MATERIALE	COD.
7x7	INOX	000 05 030
9x9		000 05 130

FASCIA CON PIEGA PER PALO INCLINATO

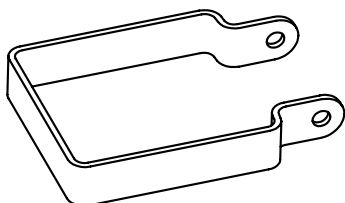

PALO	MATERIALE	COD.
7x7	INOX	000 05 034
8x8		000 05 035
9x9		000 05 036

FASCIA SEPARATA CON VITI

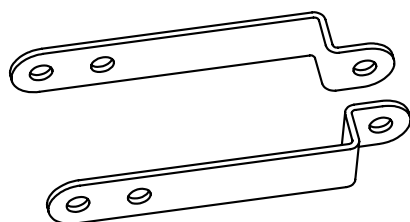

PALO	MATERIALE	COD.
7x7	INOX	000 05 015
8x8		000 05 115
9x9		000 05 215

COLLARI E FASCE

COLLARE PER PALO INCLINATO CON DOPPIO FORO COMPLETO

PALO	MATERIALE	COD.
7x7	INOX	000 05 330
9x9		000 05 230

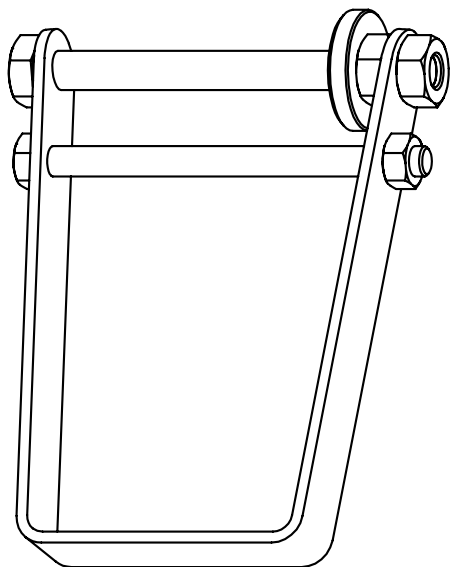

COLLARE DOPPIO PER PALI 7x7 E 9x9 COMPLETO

MATERIALE	COD.
INOX	000 05 051

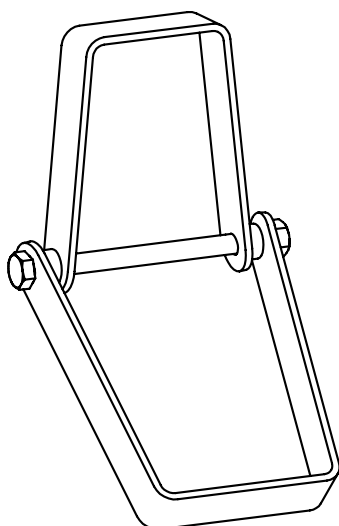

ANCORAGGI

TENDIANCORA

MATERIALE

ACCIAIO ZINCATO A CALDO

COD.

000 03 002

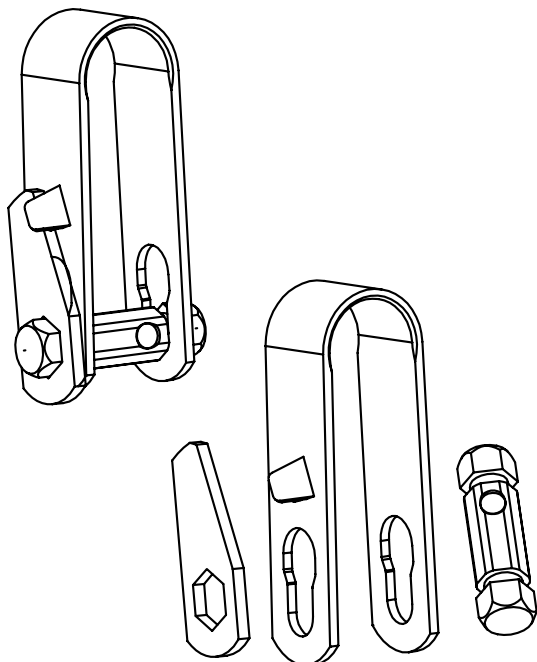

MATERIALE

INOX

COD.

000 03 402

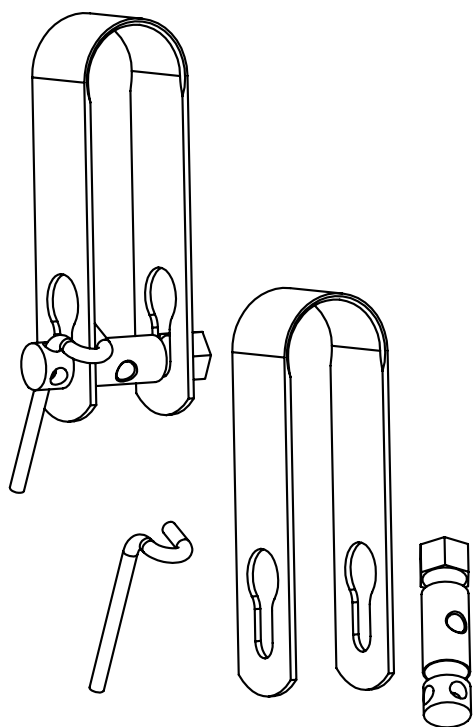

ANCORAGGI

TENDIANCORA GRANDE

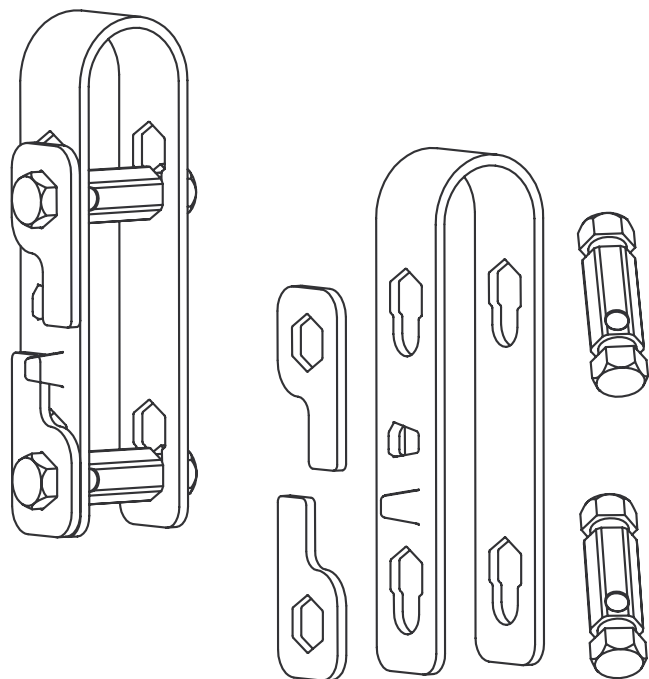

MATERIALE	COD.
Fe ZINCATO A CALDO (2 PERNI 2 PIASTRINE)	000 09 001
Fe ZINCATO A CALDO (1 PERNO 1 PIASTRINA)	000 09 501

TENDIANCORA GRANDE CORTO

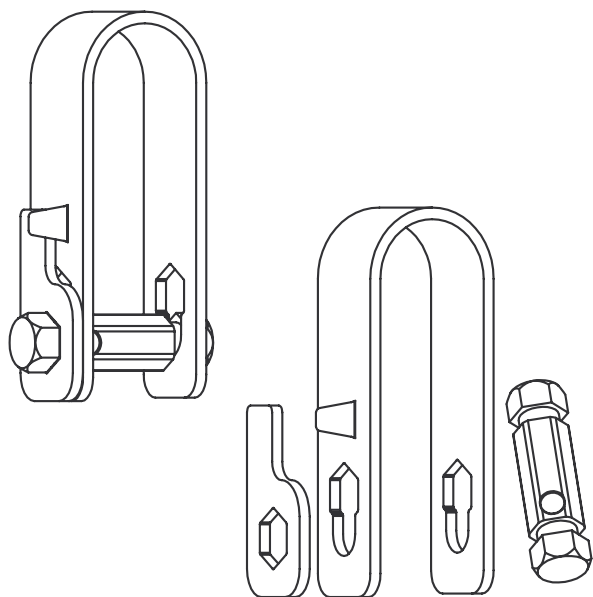

MATERIALE	COD.
Fe ZINCATO A CALDO (1 PERNI 1 PIASTRINE)	000 12 515

ANCORAGGI

TENDIANCORA GRANDE CON SMUSSO

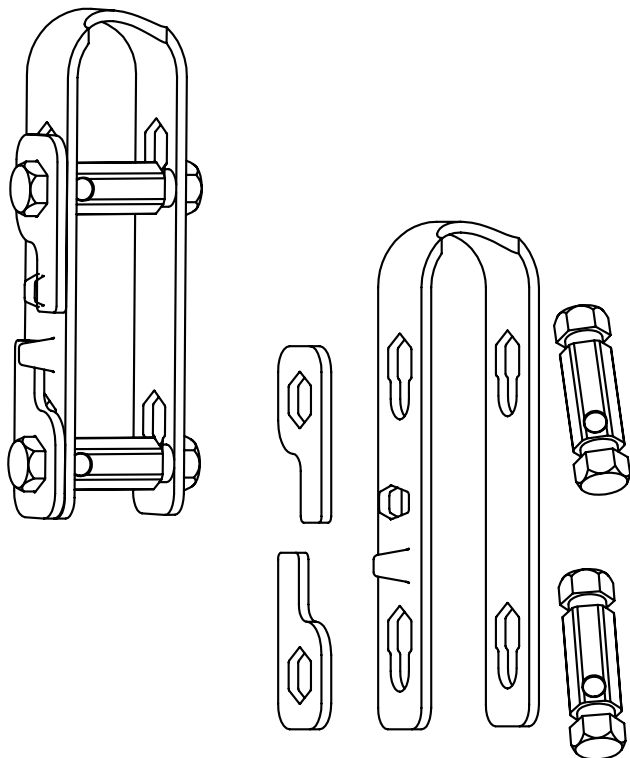

MATERIALE	COD.
Fe ZINCATO A CALDO (2 PERNI 2 PIASTRINE)	000 09 401
Fe ZINCATO A CALDO (1 PERNO 1 PIASTRINA)	000 09 601

TENDIANCORA GRANDE CORTO CON SMUSSO

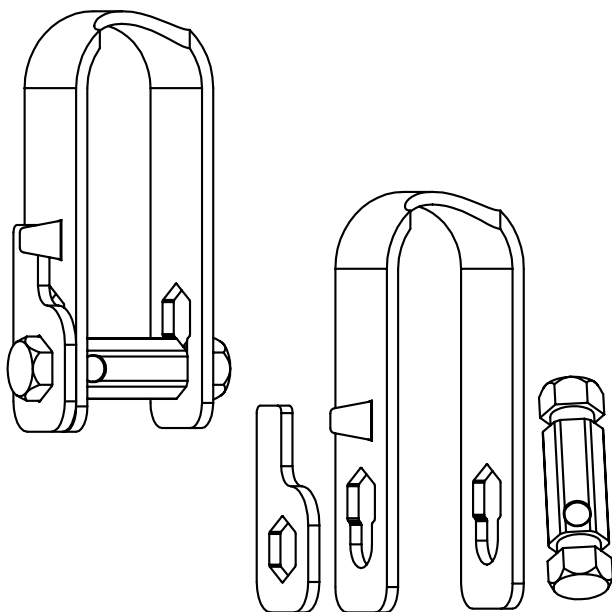

MATERIALE	COD.
Fe ZINCATO A CALDO (1 PERNI 1 PIASTRINE)	000 12 015

CAVALLOTTI

CAVALLOTTO TONDO CON E SENZA DADI (MISURE SU RICHIESTA)

MATERIALE
CRAPAL / Fe ZINCATO

COD.

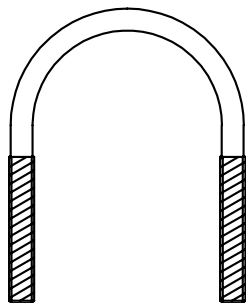

CAVALLOTTO CON E SENZA DADI (MISURE SU RICHIESTA)

MATERIALE
CRAPAL / Fe ZINCATO

COD.

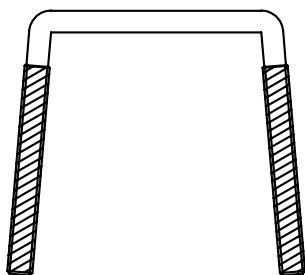

CAVALLOTTO 90° CON E SENZA DADI (MISURE SU RICHIESTA)

MATERIALE
CRAPAL / Fe ZINCATO

COD.

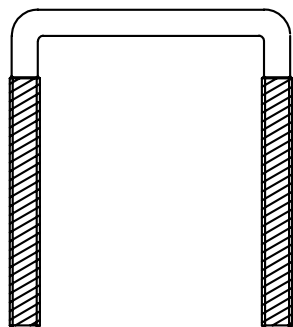

PIASTRE ANTI-SFONDAMENTO

PIASTRA ANTI-SFONDAMENTO

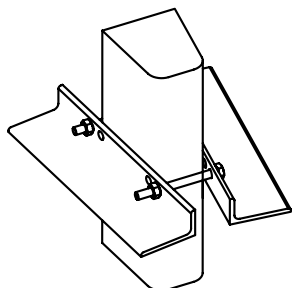

TIPO	PALO	PROFIL.	MATERIALE	COD.
4 FORI	10x12	80x40x6	Fe GREZZO	000 18 017
			Fe ZIN CALDO	000 18 217

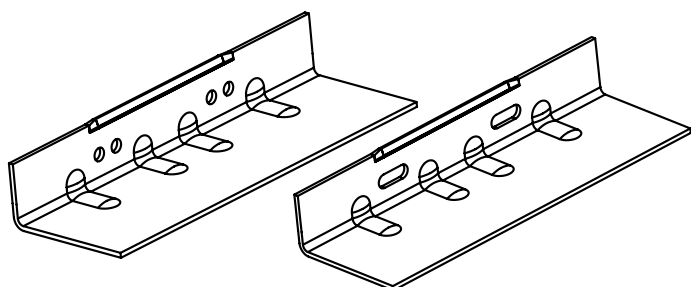

TIPO	PROFIL.	MATERIALE	COD.
FORI	330x107x53	ZINCATO	000 19 001
ASOLA	330x107x53	ZINCATO	000 19 004

PIASTRA LAMIERA PER TESTATA PER PALI PROFIL ALSACE

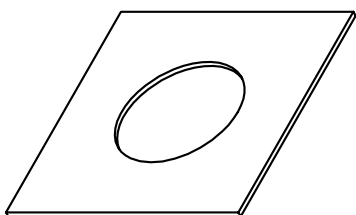

MATERIALE	COD.
LAMIERA ZINCATA	113 06 001

BASE PIASTRA ANTI-SFONDAMENTO TIPO P

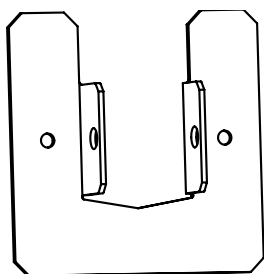

PALO	DIMENSIONI	MATERIALE	COD.
60x68	150x150	GREZZO	000 18 008
60x68		Fe ZIN CALDO	000 18 108
60x68		CORTEN	000 18 208
60x68		ELETTROLIT.	000 18 308

BASE PIASTRA ANTI-SFONDAMENTO TIPO M

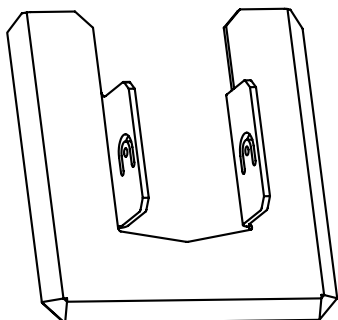

PALO	DIMENSIONI	MATERIALE	COD.
60x68	150x150	GREZZO	000 18 011
60x68		Fe ZIN CALDO	000 18 111
60x68		CORTEN	000 18 211
60x68		ELETTROLIT.	000 18 311

FILO INOX

FILO



Ø	MATERIALE	COD.
1.00	INOX 304	
1.20		
1.40		
1.60		
1.80		
2.00		

Ø	MATERIALE	COD.
3.00	INOX 304 RICOTTO	